

**INSTRUCTION MANUAL  
COMPUTERIZED TONOMETER**

---

***CT-80***

# INTRODUCTION

Thank you for purchasing the TOPCON Computerized Tonometer CT-80.

(To get the best use from the instrument, please carefully read these instructions and keep this Instruction Manual in a convenient location for future reference.)

---

## This instrument features the following:

- An exact, non-contact intraocular pressure measurement that can be done by air ejection.
  - An alignment bar that enables easy operation.
- 

This text outlines the Computerized Tonometer CT-80 and describes basic operations, troubleshooting, checking, maintenance and cleaning.

To encourage the safe, efficient use of this instrument and prevent danger to the operator and others, we suggest you carefully read the “Displays for Safe Use” and the “Safety Cautions”.

Again, please keep this Instruction Manual in a convenient location for future reference.

---

## Precautions

- This machine is a precision instrument; install it in a place set to the following conditions: temperature (10~60°C), humidity (30~85%) and atmospheric pressure (70~106KPa). Avoid direct exposure to sunlight.
- To ensure smooth operation, install the instrument on a level place free of vibrations. Also, do not place any objects on the instrument.
- Before using the instrument, connect all cables correctly.
- Use the specified source voltage.
- When not in use, turn the power off and put the measuring window cap and dust cover on.
- To ensure a correct reading, do not soil the measuring window with finger prints, dust, etc. Also, do not touch the measuring nozzle except when cleaning.

CLASS I



IEC601-1







0123

# DISPLAY FOR SAFE USE

In order to encourage the safe use of the product and prevent any danger to the operator and others or damage to properties, important warnings are placed on the product and inserted in the instruction manual.









We suggest that everyone understand the meaning of the following displays and icons before reading the “Safety Cautions” and text.

DISPLAY	MEANING
 <b>WARNING</b>	Ignoring or disregarding this display may lead to death or serious injury.
 <b>CAUTION</b>	Ignoring or disregarding this display may lead to personal injury or physical damage.
<ul style="list-style-type: none"><li>• Injury refers to cuts, bruises, sprains, fractures, burn, electric shock, etc.</li><li>• Physical damage refers to extensive damage to buildings or equipment and furniture.</li></ul>	











ICONS	MEANING
	This icon indicates Hazard Alerting (Warning). Prohibition. Specific content is expressed with words or an icon either inserted in the icon itself or located next to the icon.
	This indicates Prohibition. Specific content is expressed with words or an icon either inserted in the icon itself or located next to the icon.
	This indicates Mandatory Action. Specific content is expressed with words or an icon either inserted in the icon itself or located next to the icon.

# SAFETY CAUTIONS



Icons	Prevention item	Page
	To avoid electrical shock, do not open the instrument. Refer all servicing to qualified personnel.	<b>45</b>
	To avoid electric shocks, do not remove the covers from the bottom and top surfaces, TV monitor, measuring unit, etc.	<b>45</b>
	To prevent shock hazard, do not allow water or other foreign matter to enter into the instrument.	—
	To avoid fire and electric shocks in case of tumbling, do not place a cup or vessel containing water/fluid on the instrument.	—
	To avoid electric shocks, do not insert objects or metals through the vent holes or gaps or contain them inside the machine body.	—
	To avoid electrical shock and fire, unplug the power cable before removing the fuse cover. Additionally, be sure to replace the fuse cover before plugging in the power cable.	<b>55</b>
	Use only the attached fuses. Using other fuses may cause a fire.	<b>55</b>
	Should any anomaly, such as smoke, occur, immediately switch OFF the power source and unplug the power cable. Continued use ignoring the condition may cause fire. Contact your dealer for repair.	—

## SAFETY CAUTIONS

Icon	Prevention item	Page
	To avoid potential injury, hold the instrument in the proper position.	<b>13</b>
	To avoid electrical shock, do not handle the power plug with wet fingers.	<b>14</b>
	Never insert your fingers under the measuring head. * Inform the patient of this, too. Careless insertion of fingers may cause injury by pinching.	<b>30</b>
	Never insert your fingers under the measuring head. * Inform the patient of this, too. Careless insertion of fingers may cause injury by pinching.	<b>34</b>
	Do not use or apply any spray-typed cleaner near the instrument. If a drop of cleaner remains inside the measuring nozzle, the patient's eye may be injured during measurement.	<b>56</b>
	Before carrying the instrument, be sure to affix it firmly by turning the fixing screw at the base. If the instrument is moved with the screw loosened, it may result in damage to the instrument.	<b>13</b>
	When moving the instrument, be sure to hold it at the bottom surface with two people. Carrying by one person may cause back injury or injury by falling parts. Also, holding areas other than the bottom surface may cause pinching fingers between parts and injury by falling parts as well as damage to the instrument.	<b>13</b>
	Before measuring, set the safety stopper. If the safety stopper is not set, it may cause injury to the eye that comes in contact with the measuring window glass. Set the safety stopper separately for the right and left eyes.	<b>31</b>
	When setting the safety stopper, do it from the instrument side (safety stopper knob side). Setting from another position does not easily allow you to check the positions of the measuring window glass and the patient's eye and may cause injury to the eye that comes in contact with the measuring window glass.	<b>31</b>
	To clean the measuring window glass and the window glass inside the measuring nozzle, use ethanol. Using other chemicals may cause damage to the patient's eye during measurement.	<b>52</b> <b>53</b>

# USAGE AND MAINTENANCE

## PURPOSE

---

This tonometer “CT-80” is a precision electrical device for medical use that must be used under the instruction of a doctor.

## USER MAINTENANCE

---

To maintain the safety and performance of the equipment, never attempt to do maintenance on your own. Ask our serviceman for repair except for the items specified here which can be maintained by the user. For details, follow the instructions.

### ● Fuse replacement

The primary fuses for the main body may be replaced by a non-trained service technician. For details, refer to “Replacing the Fuse” on page 55.

### ● Cleaning of measuring window

Cleaning of the measuring window glass is possible. For details, refer to the instructions in “Cleaning the Measuring Window Glass” on page 52.

### ● Cleaning of window inside the nozzle

Cleaning of the window inside the nozzle is possible by following the instruction in “Cleaning the Window Glass inside the Nozzle” on page 53.

## ESCAPE CLAUSE

- TOPCON shall not take any responsibility for damage due to fire, earthquakes, actions by a third party or other accidents, or the negligence and misuse of the user and use under unusual conditions.
- TOPCON shall not take any responsibility for damage derived from the inability to use this equipment, such as a loss of business profit and suspension of business.
- TOPCON shall not take any responsibility for damage caused by operations other than those described in this Instruction Manual.
- Diagnoses shall be made on the responsibility of pertaining doctors and TOPCON shall not take any responsibility for the results of such diagnoses.

# WARNING INDICATIONS AND POSITIONS

To ensure the safe usage of this equipment, precaution indications are provided. Abide by the following warning instructions. If any of the following labels are missing, please contact us at the address printed on the back cover of this manual.

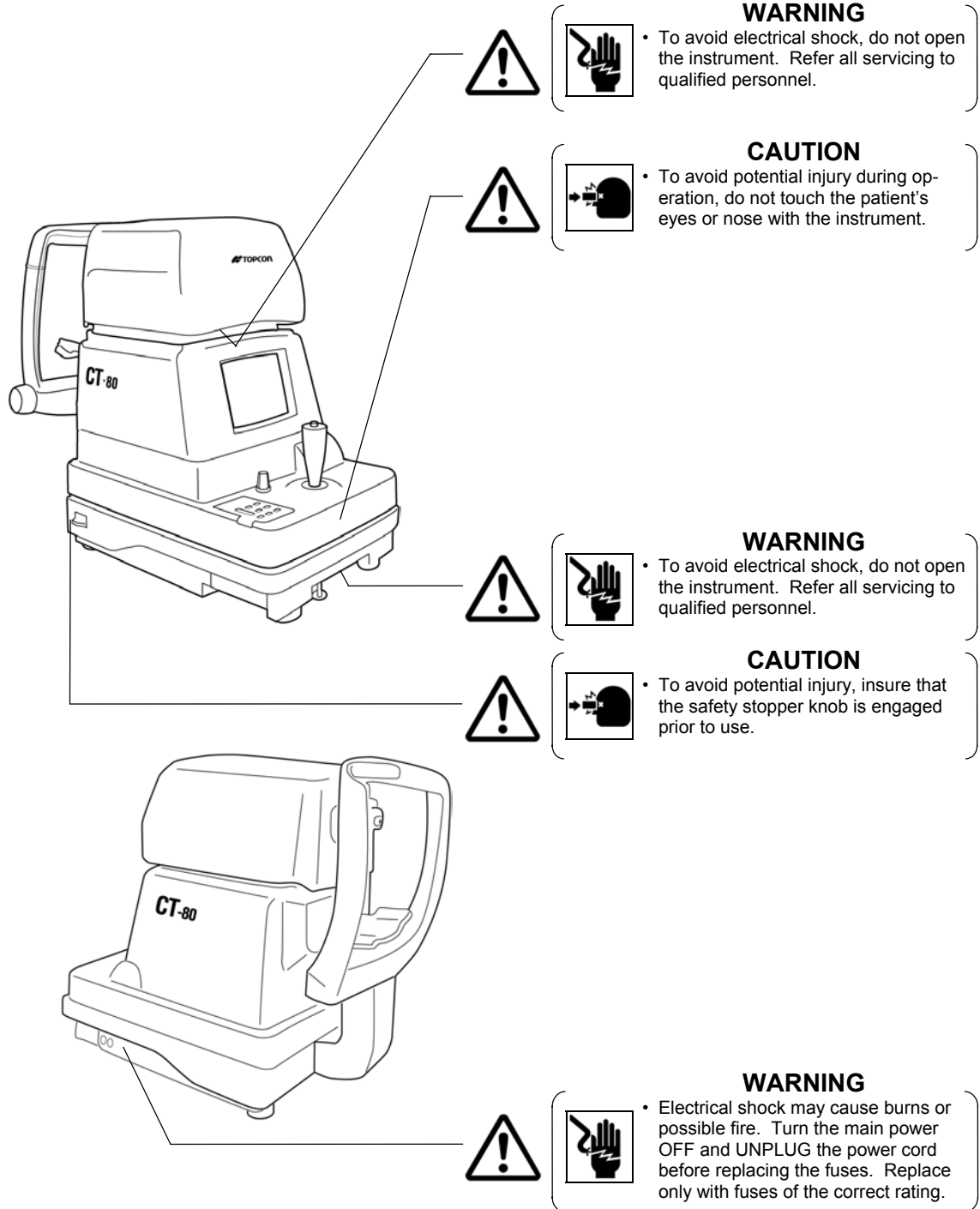

The diagram shows the CT-80 instrument from three perspectives: a front view, a side view, and a rear view. Each view has callout lines pointing to specific warning and caution labels. The labels include a general warning triangle, a warning icon (hand with lightning bolt), and a caution icon (head with lightning bolt).

**WARNING**

- To avoid electrical shock, do not open the instrument. Refer all servicing to qualified personnel.

**CAUTION**

- To avoid potential injury during operation, do not touch the patient's eyes or nose with the instrument.

**WARNING**

- To avoid electrical shock, do not open the instrument. Refer all servicing to qualified personnel.

**CAUTION**

- To avoid potential injury, insure that the safety stopper knob is engaged prior to use.

**WARNING**

- Electrical shock may cause burns or possible fire. Turn the main power OFF and UNPLUG the power cord before replacing the fuses. Replace only with fuses of the correct rating.

# CONTENT

Introduction	<b>1</b>	
Display for Safe Use	<b>2</b>	How to Print Out Measurement Values <b>42</b>
Safety Cautions	<b>3</b>	How to Correct Measurement Values <b>43</b>
Usage and Maintenance	<b>5</b>	Input/Output via RS-232C <b>44</b>
Escape Clause	<b>5</b>	
Warning Indications and Positions	<b>6</b>	
Main Body Components	<b>8</b>	<b>ICE</b>
Control Panel Components	<b>9</b>	Checking Operations <b>45</b>
Monitor Screen Components	<b>10</b>	
Contents of Printer Output	<b>11</b>	Optional Accessories <b>46</b>
Standard Accessories	<b>12</b>	Specifications & Performance <b>46</b>
		RS-232C Communication Specifications <b>47</b>
How to Install the Instrument	<b>13</b>	Accuracy Maintenance <b>52</b>
How to Connect the Power Cable	<b>14</b>	Special Notes on Cleaning <b>56</b>
How to Connect External I/O Terminals	<b>14</b>	
Initial Settings	<b>15</b>	
How to Set Printer Paper	<b>23</b>	
How to Reset from Power Save Status	<b>28</b>	
Preparations Before Measurement	<b>29</b>	
Measurement Under Auto Mode	<b>33</b>	
Measurement Under Manual Mode	<b>38</b>	
How to Delete Measurement Values	<b>41</b>	



# COMPONENTS

## MAIN BODY COMPONENTS

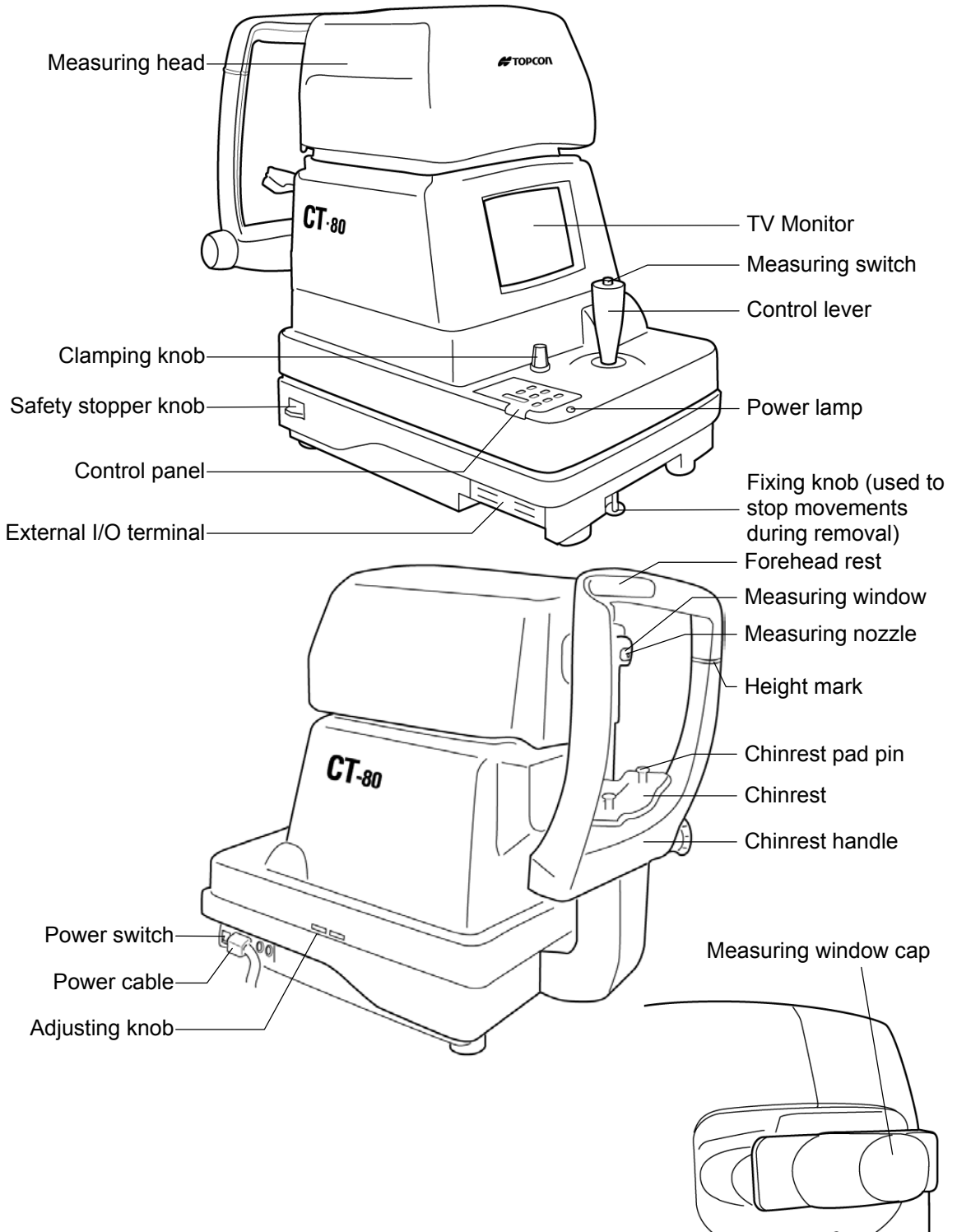

## CONTROL PANEL COMPONENTS

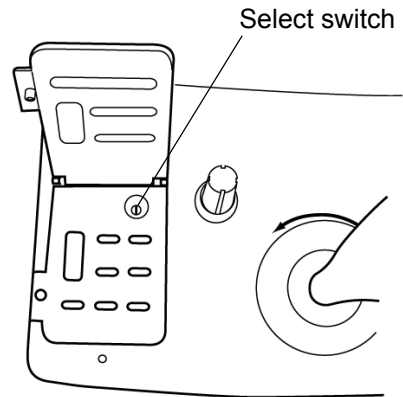
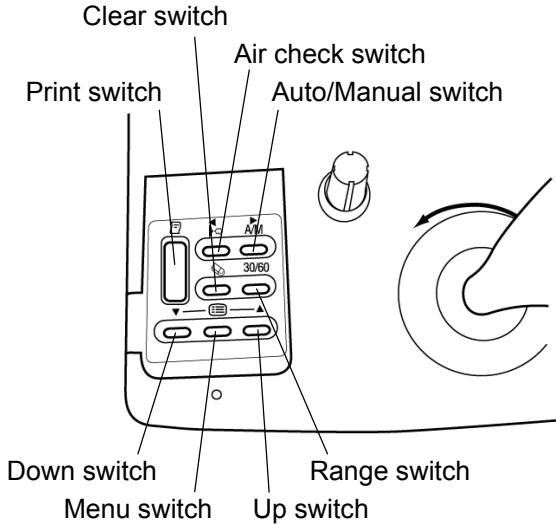

- Print switch** ..... Prints out the screen readings. When there is no reading, holding the switch down feeds the paper.
- Range switch** ..... Switches the range between 0-30 and 0-60.
- Clear switch** ..... Deletes all the measurement values from the screen.
- Menu switch** ..... Displays the Menu screen.
- Auto/Manual switch**..... Switches the mode between auto and manual. Also, when selecting menu software, it moves the cursor right (▶).
- Air check switch** ..... Performs an air check. Also, when selecting menu software, it moves the cursor left (◀).
- Down switch** ..... When selecting menu software, it moves the cursor down (▼).
- Up switch**..... Range switch. When selecting menu software, it moves the cursor up (▲).

## MONITOR SCREEN COMPONENTS

### Measurement Screen (Auto mode, alignment)

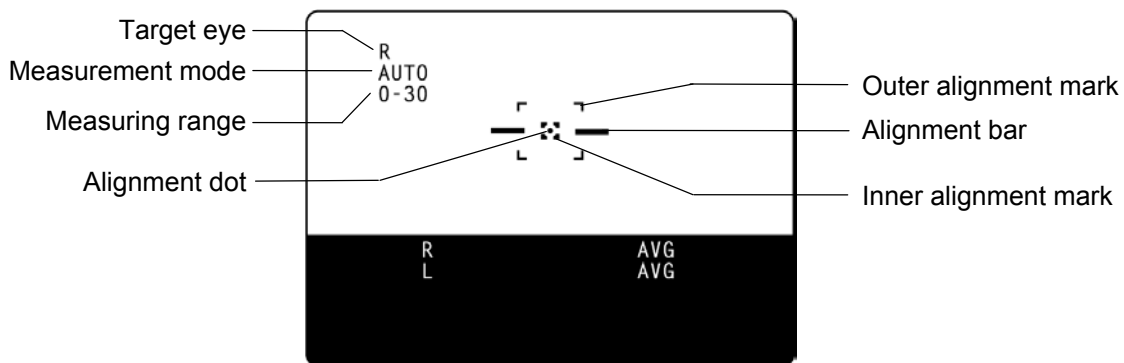

### Measurement Screen (Manual mode, alignment OK)

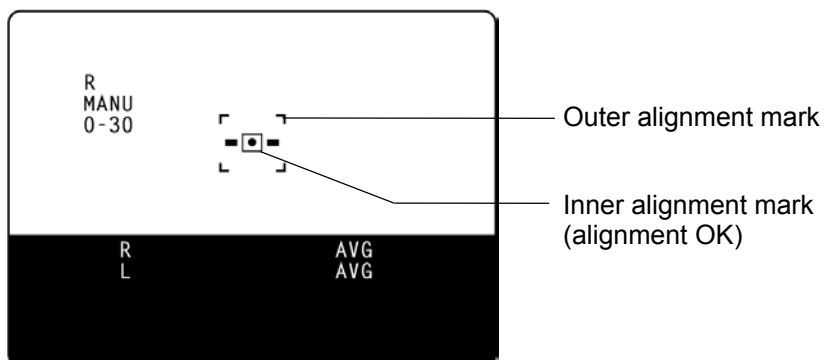

### Menu Screen

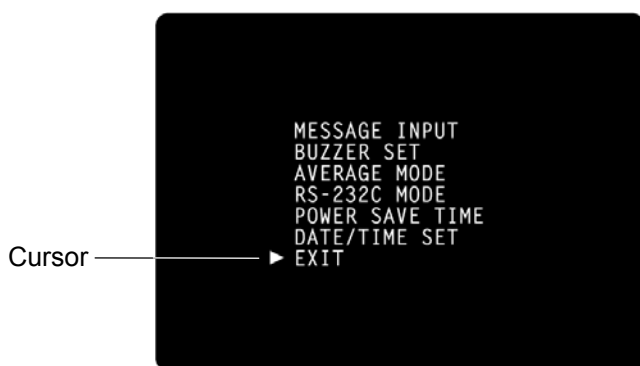



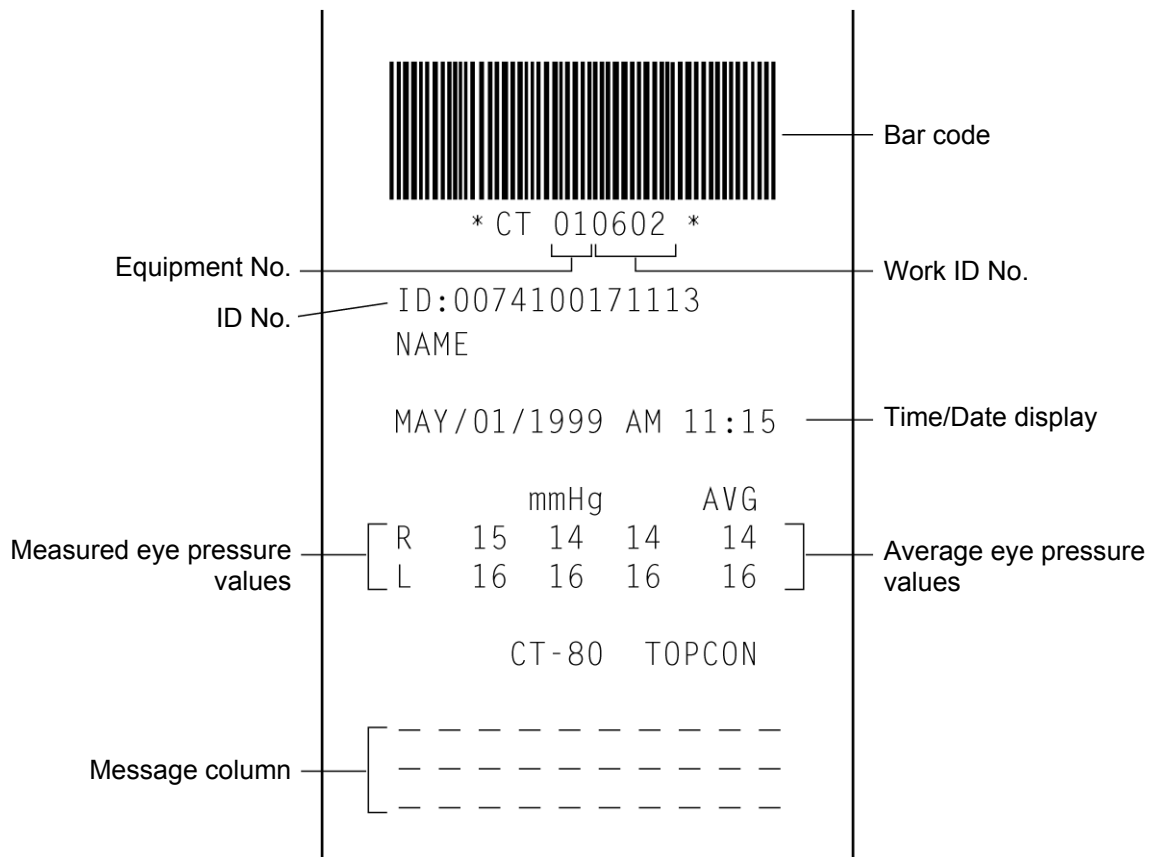



# CONTENTS OF PRINTER OUTPUT

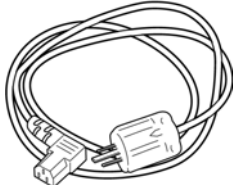
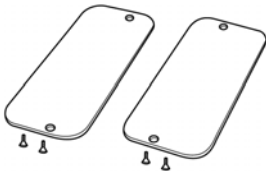

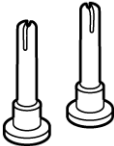
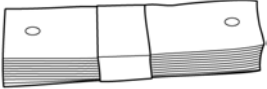
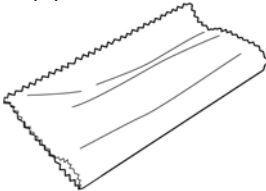
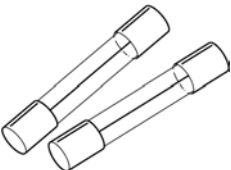
## STANDARD ACCESSORIES

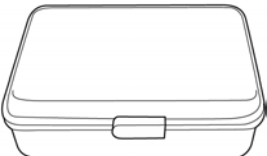
The following are the standard accessories. The figures in parentheses are the quantities. Please check to see that all accessories are contained.

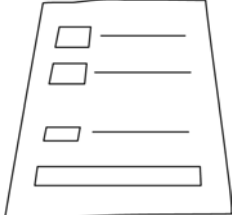
<p>Power cable (1)</p> 	<p>Rail cover (2)</p> 
<p>Printing paper (2)</p> 	<p>Chinrest pin (2)</p> 
<p>Chinrest pad (1)</p> 	<p>Silicone cloth (1)</p> 
<p>Fuse (2) * Different by destinations</p> 	<p>Dust cover (1)</p> 
<p>Cleaning kit (1)</p> 	<p>Instruction Manual, Unpacking and Assembly (1 each)</p> 
	<p>Window glass cleaning procedure (1)</p> 

# PARATIONS

## HOW TO INSTALL THE INSTRUMENT



**CAUTION**

Before carrying the instrument, be sure to affix it firmly by turning the fixing screw at the base. If the instrument is moved with the screw loosened, it may result in damage to the instrument.



**CAUTION**

When moving the instrument, be sure to hold it at the bottom surface with two people. Carrying by one person may cause back injury or injury by falling parts. Also, holding areas other than the bottom surface may cause pinching fingers between parts and injury by falling parts as well as damage to the instrument.



**CAUTION**

To avoid potential injury, hold the instrument in the proper position.

- 1 Fasten the clamping knob.
- 2 Hold the instrument body firmly at the specified positions and place it on the automatic instrument table.  
For the automatic instrument table, see "OPTIONAL ACCESSORIES" on page 46.

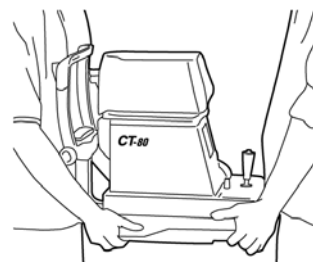
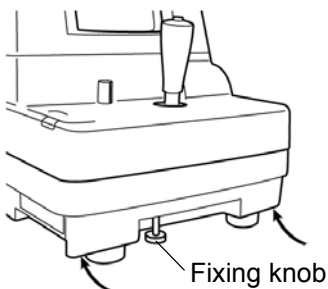
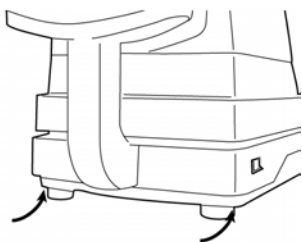

Specified holding positions

Holding the instrument

- 3 After installing the instrument, loosen the fixing knob. Now the body components can be moved.
- 4 If the machine body is slightly off level, properly turn the adjusters at the four corners for fine adjustment.  
Do not unscrew the adjusters more than 1 cm.

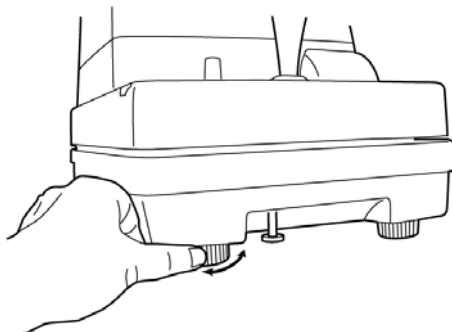

## HOW TO CONNECT THE POWER CABLE



### CAUTION

To avoid electrical shock, do not handle the power plug with wet fingers.

- 1 Make sure the **POWER SWITCH** is OFF.
- 2 Attach the power cable to the machine body.

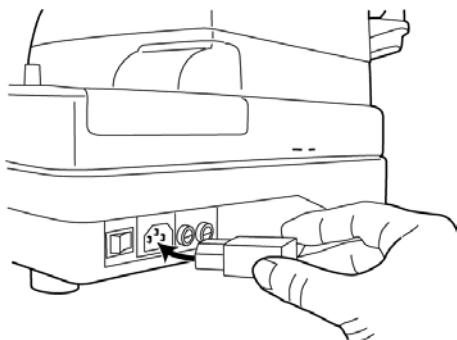

- 3 Plug the power cable into the 3-pin AC receptacle with grounding.

## HOW TO CONNECT EXTERNAL I/O TERMINALS

### S-232C OUT

This machine can be connected to another device, including a personal computer via the RS-232C OUT terminal.

- 1 Connect the cable to the RS-232C OUT terminal of this machine.
- 2 Connect the other cable end to another device.

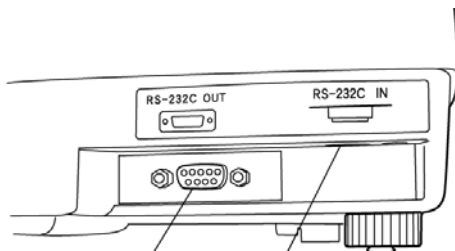

### S-232C IN

Output terminal      Input terminal

This machine can be connected to another device, including a bar code reader via the RS-232C IN terminal.

- 1 Connect the cable to the RS-232C IN terminal of this machine.
- 2 Connect the other cable end to the external device.

## INITIAL SETTINGS

During the initial setting, date, time, operating time of the power save function, RS-232C, mode of average value, buzzer and message can be set.

### Preparations

- 1 Make sure the power cable is connected.  
For connection, see “HOW TO CONNECT THE POWER CABLE” on page 14.
- 2 Check the no-patient condition of the instrument and turn the **POWER SWITCH** ON.



#### MEMO

- When the machine is moved from a cold room to a warm room or when the room temperature suddenly rises, it may cause dewing inside the machine and disable measurement. In this case, leave the machine alone for about 30min until it reaches room temperature.

### Displaying The Menu Screen

- 1 Make sure that the Measurement screen is displayed.
- 2 Press  on the control panel.  
The Menu screen is displayed.

### Returning To The Measurement Screen

- 1 Press ,  on the control panel, move the cursor to “EXIT” and press **MEASUREMENT SWITCH**.





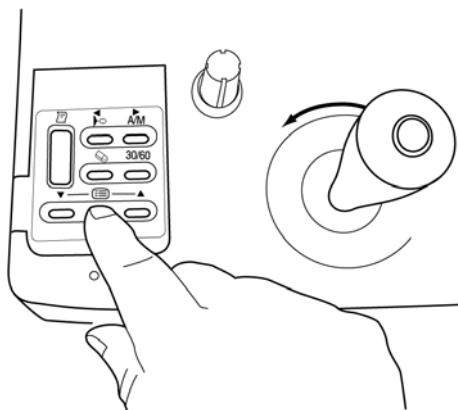

Or, press  on the control panel. The Measurement screen returns.





## Time/Date Setting

Example of operation: Illustrations show time setting.

- 1 Press  on the control panel to get the Menu screen.
- 2 Press ,  on the control panel, move the cursor to "DATE/TIME SET" and press  .





The Date/Time setting screen is displayed.



- 3 Make sure that the display "BATTERY → O.K." appears.







**MEMO** If the display is "BATTERY → N.G.", the built-in clock battery is used up. Contact your dealer. Additionally, when the battery becomes exhausted, time and date items are not printed and "DATE" is displayed instead.

- 4 Press ,  on the control panel, move the cursor to "HOUR" and press  .

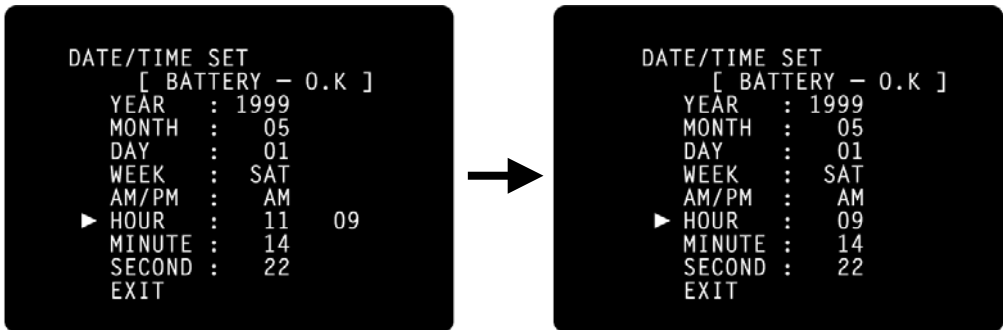

- 5 Press ,  of the control panel, renew figures and press  .  
The renewed figures are inputted.





- 6 Press ,  of the control panel, move the cursor to “EXIT” and press  .

 **MEMO** Date and other items can also be renewed at the same time.

### ● Setting The Power Save Time

A time for the power save function to achvale can be selected from 10, 20, 30 or 60min.  
For shipment, 10min. is set.

- 1 Return to the Menu screen.
- 2 Press ,  on the control panel, move the cursor to “POWER SAVE TIME” and press  . The Power Save Time Setting screen is displayed.

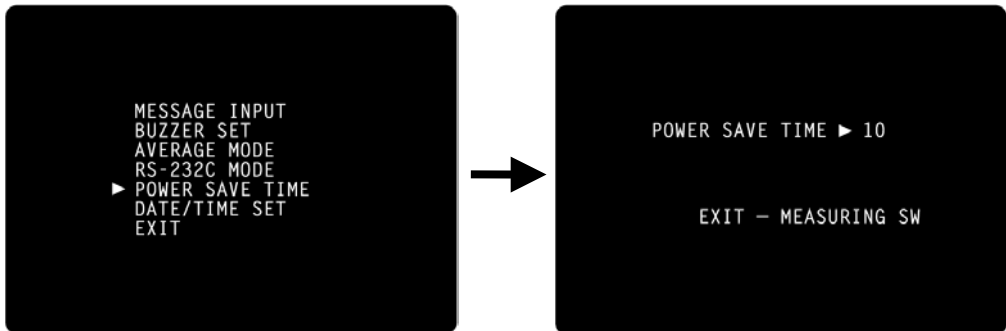

- 3 Press ,  on the control panel and change the power save time.

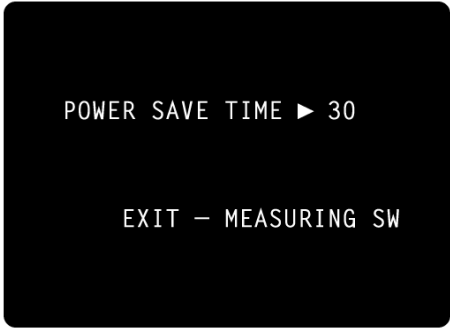

### MEMO

▶ 5 ↔ 10 ↔ 20 ↔ 30 ↔ 60 ◀

**4** Press **MEASUREMENT SWITCH**. The Menu screen is displayed.

### S-232C INPUT/OUTPUT Settings

For shipment, settings are EQUIPMENT (Equipment No.) No.1, FORMAT (communication mode) OFF, and SPEED (communication speed) 2400. Each time **▲** or **▼** is pressed, the display changes as follows:







**1** Return to the Menu screen.

**2** Press **▲**, **▼** of the control panel, move the cursor to “RS-232C MODE” and press **MEASUREMENT SWITCH**.







The RS-232C Mode is displayed.

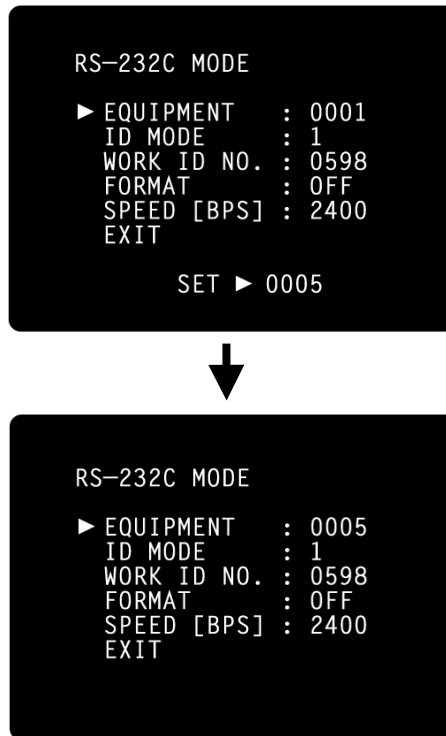





- 3 Press ,  on the control panel, move the cursor to “EQUIPMENT” and press .
- 4 Press ,  on the control panel, change the equipment No. and press .





**MEMO** The equipment No.(EQUIPMENT) can be selected from 0000 to 0099. Each time ,  is pressed, the display changes as follows:

 OFF ↔ MODE1 ↔ MODE2 ↔ MODE3 ↔ MODE4 ↔ 

When setting the speed, the display changes from 2400-9600 each time ,  is pressed.

 2400 ↔ 9600 



**MEMO** “EQUIPMENT” and “WORK ID NO.” can be reset by pressing .

- 5 Press ,  on the control panel, move the cursor to “EXIT” and press . The Menu screen returns.

## Setting The Average Value Mode

The average value display of the measurement values can be selected from integer and decimal displays. For shipment, the integer display is set.

**1** Return to the Menu screen.

**2** Press ,  on the control panel, move the cursor to “AVERAGE MODE” and press .



The Average Value Mode screen is displayed.

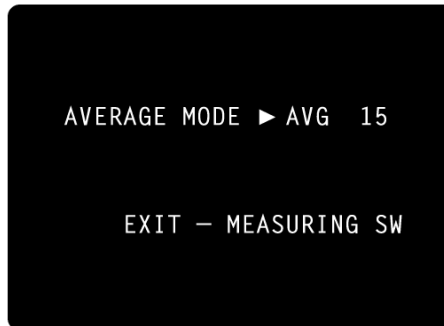

**3** Press ,  on the control panel to change the mode.

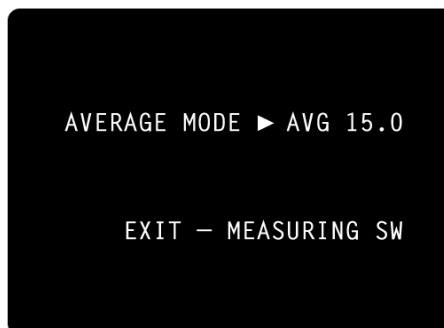

**MEMO**

- 15 : The average value is displayed as an integer (by rounding fractions to the nearest whole number).
- 15.0 : The average value is displayed up to one decimal (by rounding fractions to the nearest tenth).

**4** Press MEASUREMENT SWITCH . The Menu screen returns.

**Setting The Buzzer**

The buzzer can be turned ON/OFF by pressing the switches on the control panel.

**1** Return to the Menu screen.

**2** Press ▲ , ▼ on the control panel, move the cursor to “BUZZER SET” and press MEASUREMENT SWITCH .

The Buzzer Setting screen is displayed.

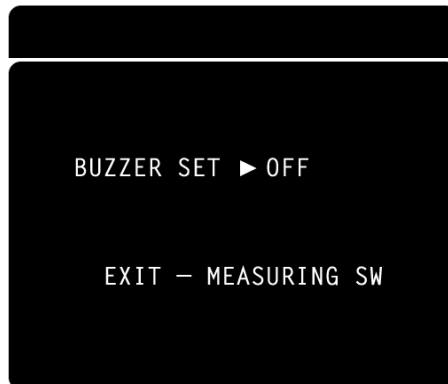

**3** Press ▲ , ▼ on the control panel to select ON/OFF.

- 4** Press **MEASUREMENT SWITCH** .  
The Menu screen returns.

## Message Input

You can add a brief message to the printout.

- 1** Return to the Menu screen.
- 2** Press **▲**, **▼** on the control panel, move the cursor to “MESSAGE INPUT” and press **MEASUREMENT SWITCH** .



The Message Input screen is displayed.

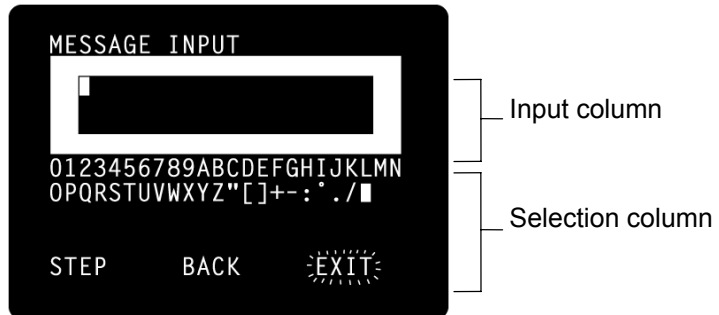

- 3** Press **▲**, **▼**, **▶**, **◀** on the control panel to move the blinking icon to a character in the selection column for input.



## MEMO

- : A space for 1 character (Use this to delete a character, too.)
- STEP : The blinking icon of the input column moves right.
- BACK : The blinking icon of the input column moves left.

- 4** Press **MEASUREMENT SWITCH** .  
The character selected by the blinking icon is inputted.



## MEMO

- 5** Press **△** , **▽** , **▶** , **◀** on the control panel, move the blinking icon in the selection column to "EXIT" and press **MEASUREMENT SWITCH** .  
The Menu screen is displayed.

## HOW TO SET PRINTER PAPER

### Auto Setting

- 1** Press the printer cover with your thumb, slide it aside and remove.  
When the right/left end is reached, the blinking icon goes down to the next line.  
A message can contain up to 3 lines, 20 characters per line.

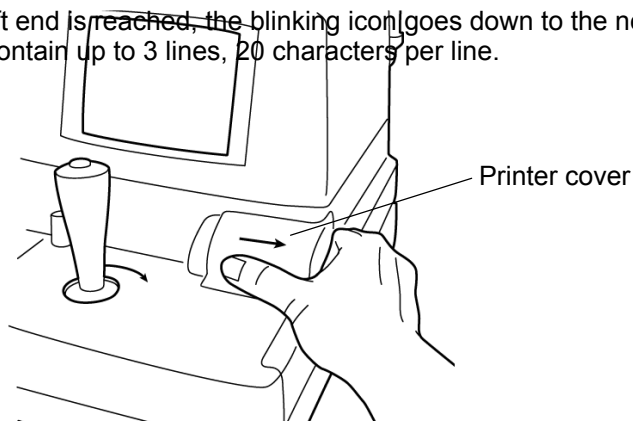



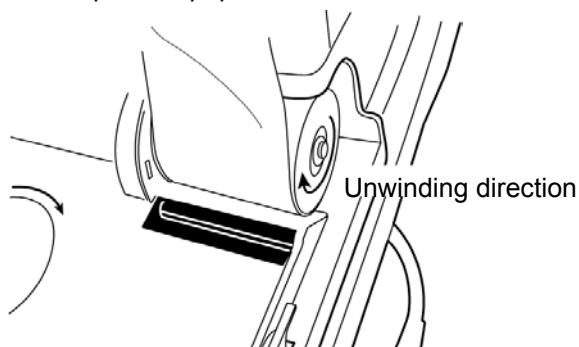

- 2** Slide the paper roll onto the paper shaft, paying attention to the direction of unwinding, and pull out the top of the paper 7-8cm.

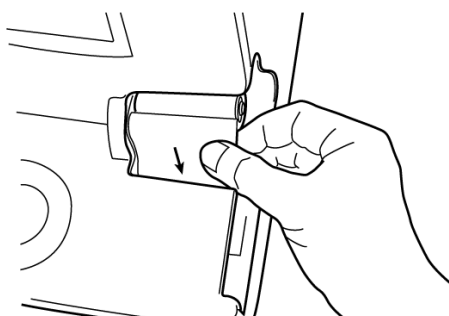

- 3** Insert the paper straight into the printer



along the paper guide.

- 4** When the top of the paper stops inside the printer, press  to further insert the paper into the printer.

Paper feeding starts when the top of the paper reaches a certain depth inside the printer.

- 5** When the top of the paper comes out 1cm or so from the outlet, release .

At this moment, hold the top of the paper firmly so that it is not rolled back.

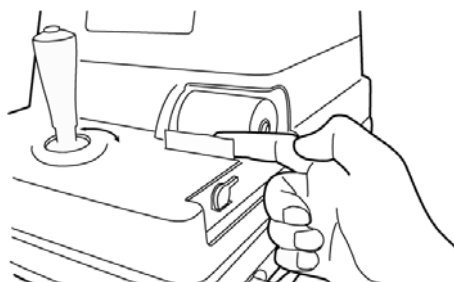

- 6** Turn the paper retainer lever to the illustrated position, and pull out the paper 2-3cm so that it comes out straight from the outlet.

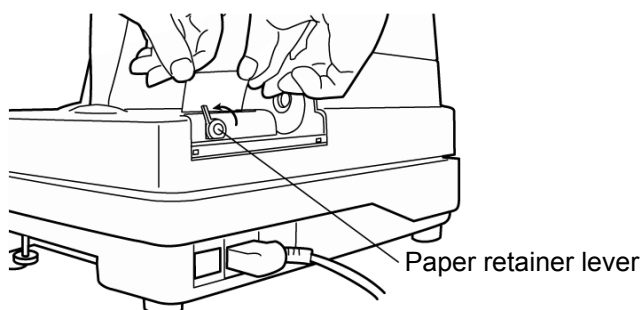

- 7** Return the paper retainer lever back to its original position.

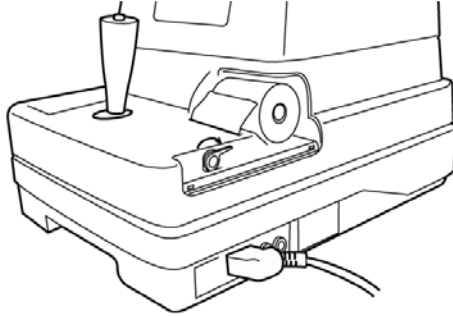

**MEMO**

- 8** Reset the printer cover, holding the top of the paper outside.

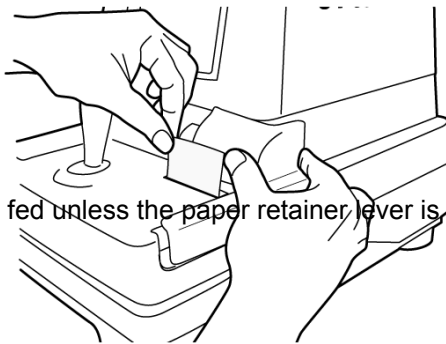

The paper is not fed unless the paper retainer lever is lowered.

**MEMO**

Use the following 58mm wide printer paper:

TF50KS-E2C

Using another paper may cause a printing noise or thin prints.

## Manual Setting

- 1** Press the printer cover with your thumb, slide it aside and remove.
- 2** Slide the paper roll onto the paper shaft, paying attention to the direction of unwinding, and pull out the top of the paper 7~8cm.
- 3** Turn the paper retainer lever in the arrow direction.

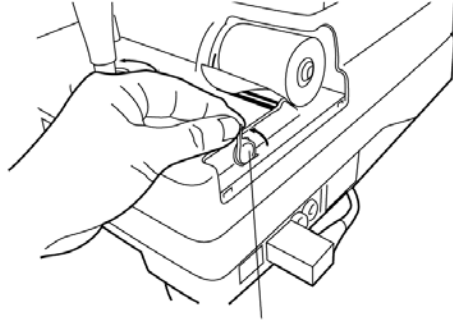

- 4** Cut the paper on the control lever side at about 2cm.

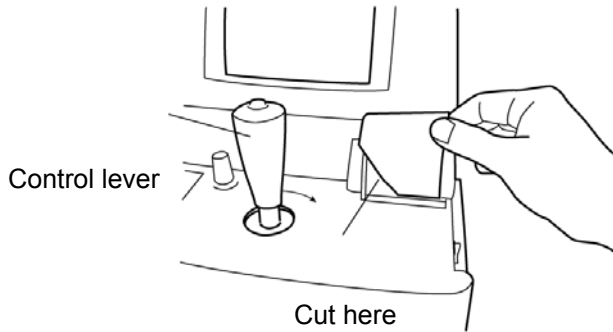

- 5** Insert the paper straight into the printer along the paper guide.

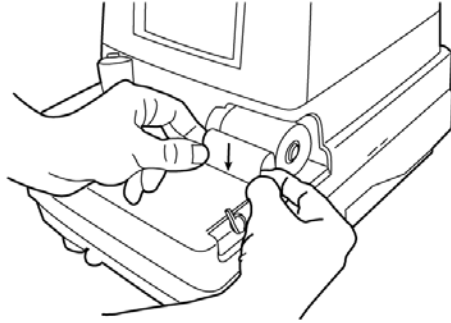

- 6** Further insert the paper and draw out the top of the paper from the outlet.

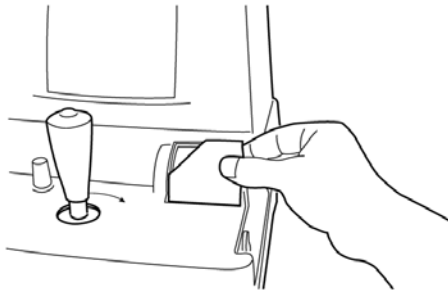

**MEMO**

- 7** Adjust the paper so that it comes out straight from the outlet, and then lower the paper retainer lever.

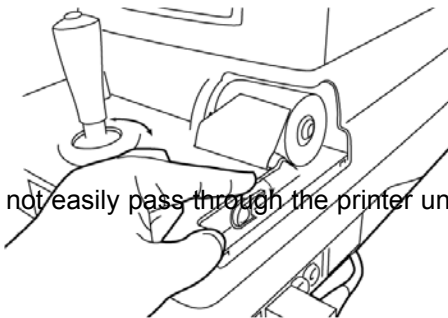

The paper does not easily pass through the printer unless it is cut on the control lever side.

- 8** Set the printer cover, holding the top of the paper outside.

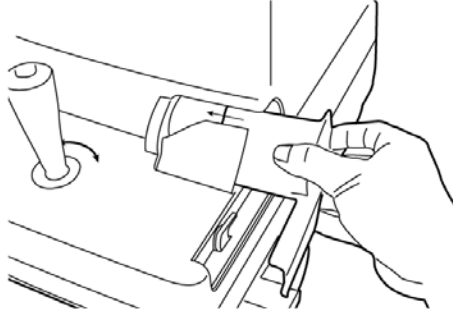

**MEMO**

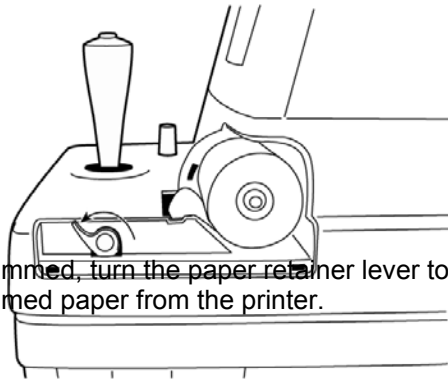

If the paper is jammed, turn the paper retainer lever to the illustrated position, and take out the jammed paper from the printer.

## HOW TO RESET FROM POWER SAVE STATUS

This machine employs a power save function. If the machine is not used during a set time, the power save function stops supplying power to the monitor and CCD camera. Under the power save status, the POWER lamp of the control panel flashes.

- 1** Press **MEASUREMENT SWITCH** .

The Monitor screen is displayed in a few seconds, when the measurements become available.

**MEMO**

After resetting, the measurement mode is AUTO and the measuring range is 0-30. Also, values measured before power saving are deleted.

# IC OPERATIONS

## PREPARATIONS BEFORE MEASUREMENT

---

### Turn ON the Power

- 1** Make sure the power cable is connected.  
For connection, see “HOW TO CONNECT THE POWER CABLE” on page 14.
- 2** Make sure the instrument is in the no-patient condition and turn ON the **POWER SWITCH**.
- 3** The Title screen is displayed, and then the Measurement screen is displayed.

### Air Check

This machine is equipped with a function for checking the correct operations measurement system inside the instrument.

- 1** Remove the measuring window cap.
- 2** Press  on the control panel.  
Air is ejected from the measuring nozzle and checking is done automatically.
- 3** Make sure “OK” is displayed on the monitor screen. The Menu screen should be displayed a few seconds afterwards.



Normal operation screen

## MEMO

If “NG (+)” or “NG (-)” is displayed, an anomaly has occurred. Turn OFF the **POWER SWITCH**, and check whether or not there is any obstacle in front of the measuring nozzle. If there is an object, remove it, and then press the **POWER SWITCH**. Press **▶◁** and perform the checking procedure again. If no object is there, a problem has occurred. Turn OFF the **POWER SWITCH**, unplug the power cable, and call your dealer.



## Setting the Patient



### CAUTION

Never insert your fingers under the measuring head.

\* Inform the patient of this, too.

Careless insertion of fingers may cause injury by pinching.

- 1** Return to the Measurement screen. Abnormal operation screen
- 2** Ask the patient to sit in front of the instrument.
- 3** Adjust the automatic instrument table or the chair for height so that the patient can put his or her chin on the chinrest in a comfortable position.
- 4** The patient places his or her chin on the chinrest and stops his or her forehead at the forehead rest.

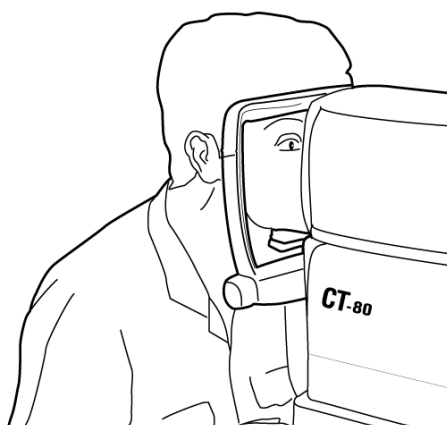

- 5** Adjust the height of the chinrest, by operating the chinrest handle, so that the tail of the patient's eye becomes level with the height mark of the chinrest post.

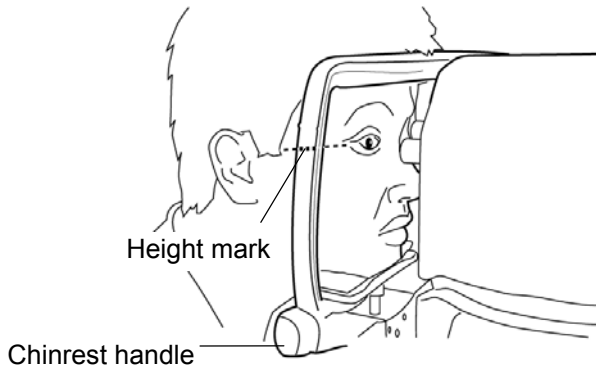

### Setting the Safety Stopper



Before measuring, set the safety stopper. If the safety stopper is not set, it may cause injury to the eye that comes in contact with the measuring window glass. Set the safety stopper separately for the right and left eyes.



When setting the safety stopper, do it from the instrument side (safety stopper knob side). Setting from another position does not easily allow you to check the positions of the measuring window glass and the patient's eye and may cause injury to the eye that comes in contact with the measuring window glass.

- 1** Hold the control lever and pull the machine body towards the operator.
- 2** Turn the control lever and adjust the height of the measuring nozzle to the center of the patient's cornea.
- 3** While holding the safety stopper knob in a pressed position, hold the control lever and slowly push out the machine body.





- 4** When the measuring nozzle reaches a position 8~10mm from the cornea, release the safety stopper knob.

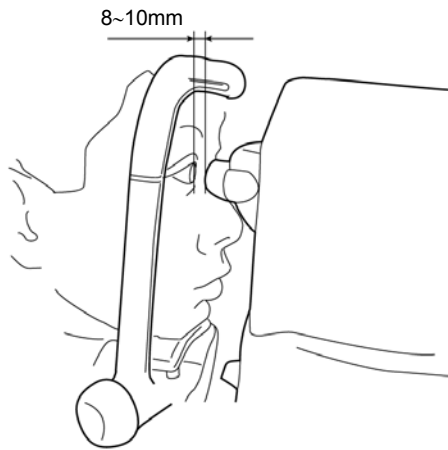

- 5** Holding the control lever, try to slightly push out the machine body to make sure the stopper is working. If the machine body does not move forward any further, the setting is completed.

## MEASUREMENT UNDER AUTO MODE

### MEMO

- Adjust the height of the automatic instrument table so that correct measurement values can be obtained by allowing the patient to undergo measurements in a comfortable position.
- Make the patient relaxed so as to secure correct measurement values; make sure the patient does not hold his breath or remain tense.

### Setting the Measurement Mode

The initial status of the measurement mode is AUTO, upon turning the power ON.

- 1 Return to the Measurement screen.
- 2 Press **AM** on the control panel and change the measurement mode display to AUTO.

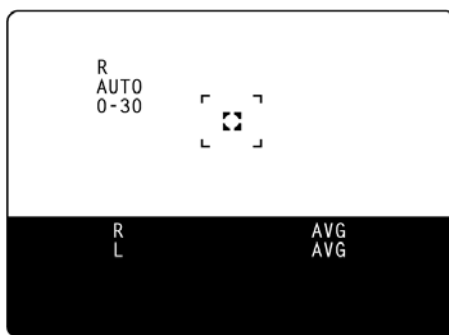
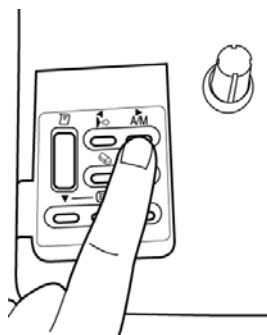

### Setting the Measuring Range

In this machine, the measuring range can be switched between 0-30 and 0-60.

Normally, the 0-30 range is used, but if the patient's intraocular pressure is high, switch it to 0-60. The initial status of the measuring range is 0-30, upon turning the power ON.

- 1 Return to the Measurement screen.
- 2 Press **30/60** on the control panel and make the measuring range display 0-30.

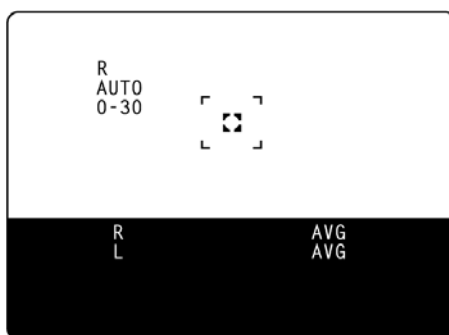
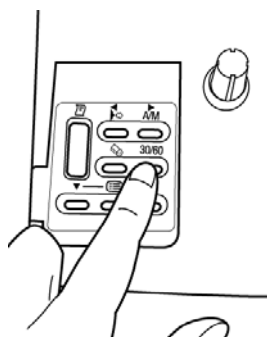

**MEMO**

It is recommended that you do intraocular pressure measurements several times. Since the intraocular pressure varies by heart beats and tears, often it is not possible to obtain exact measurement values by measuring only once or twice.

The alignment operation can be performed with the control lever.

**MEMO**

Moving the machine body by the control lever

- When the machine body needs to be moved slightly back and forth or right and left, move the control lever in each direction.

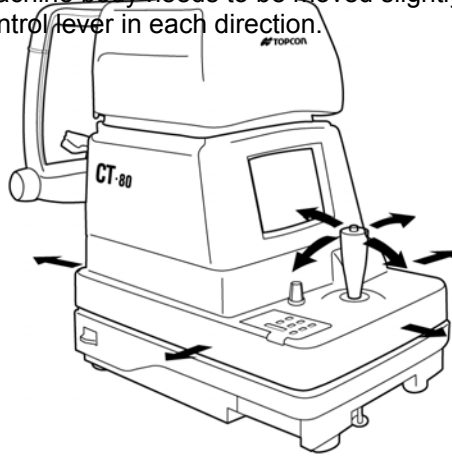

Operating the control lever  
(back and forth, right and left)



**CAUTION**

Never insert your fingers under the measuring head.  
\* Inform the patient of this, too.  
Careless insertion of fingers may cause injury by pinching.

- To move the measuring head vertically, turn the control lever right for raising and left for lowering.

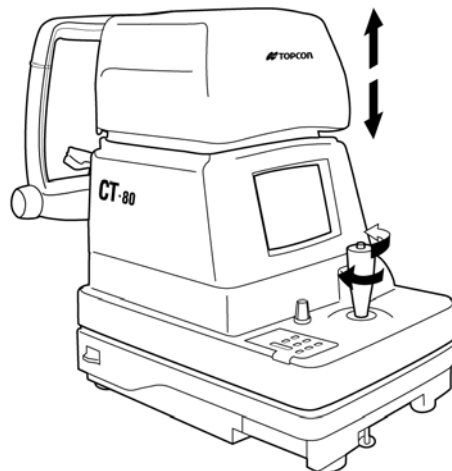

Operating the control lever  
(up and down)

- 1** Hold the control lever and pull the machine body towards the operator.

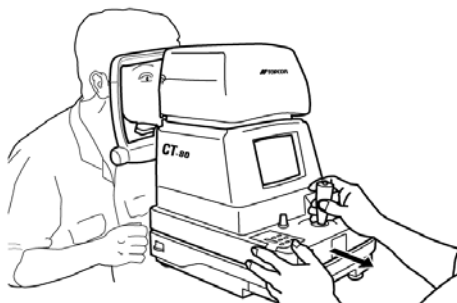

- 2** Move the control lever in directions as needed and bring the patient's eye to the center of the monitor screen.

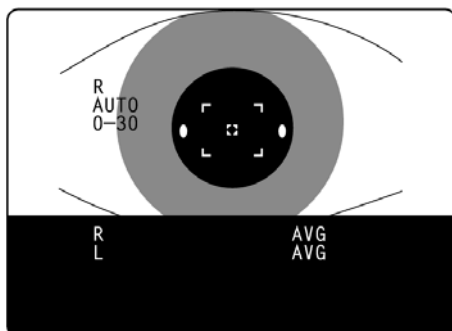

- 3** Tell the patient to gaze at the yellow-green light.

- 4** Move the machine body toward the patient and focus the target eye. A vague alignment dot becomes seen reflected in the cornea.

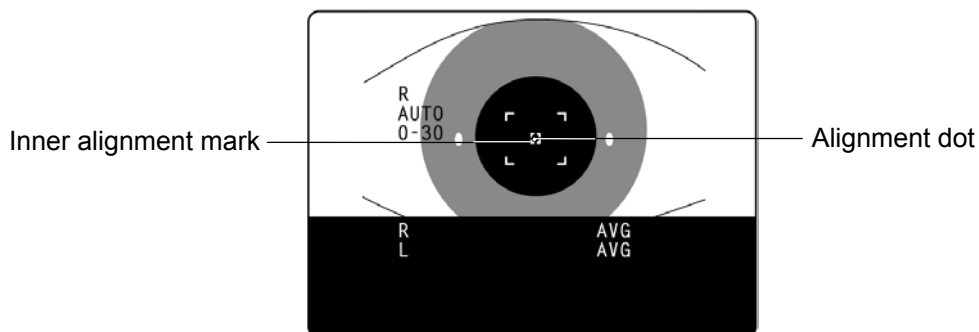

- 5 Move the machine body in directions as needed in order to get the alignment dot within the inner alignment mark on the monitor screen.
- 6 Holding the alignment dot within the inner alignment mark, slightly push the machine body toward the patient.  
When the machine body approaches the target eye, the alignment bar and “FORWARD” display appear on the monitor screen.

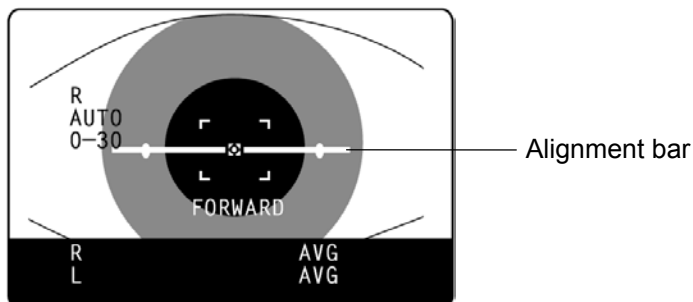

At this moment, be careful not to catch eyelashes and eyelids within the outer alignment mark so as to ensure correct measurements.



If the instrument is too close to the target eye, with regard to the alignment reference position, “TOO CLOSE” is displayed on the monitor screen, and if it is too far, “FORWARD” is displayed.

The alignment bar is displayed as a broken line when the instrument is close to the target eye and as a solid line when it is far. Also, the alignment bar is shortened accordingly as it approaches the alignment reference position.

These factors are displayed only when the alignment dot is near the inner alignment mark.

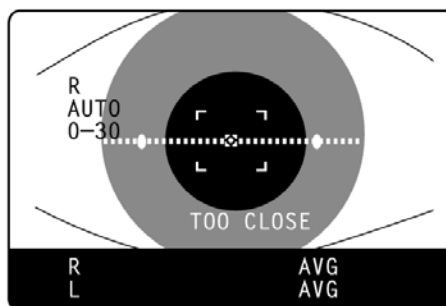
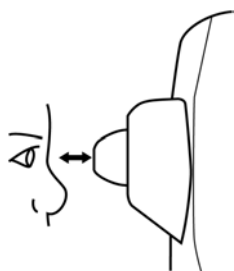

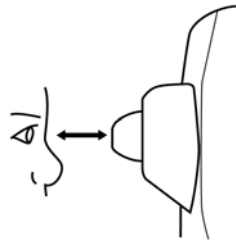

Reference position

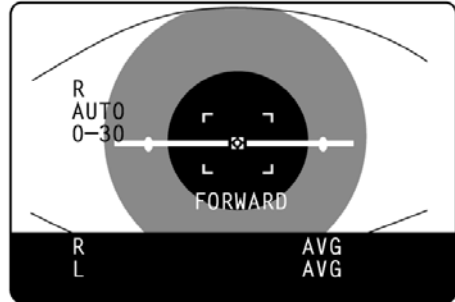
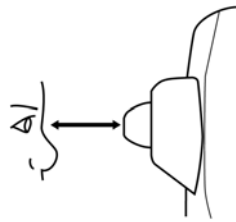
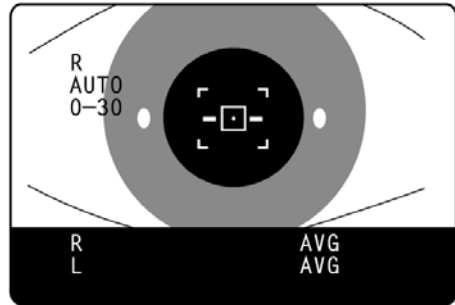

- 7** After the alignment bar is displayed, push the machine body out a little bit more. When the alignment is adjusted, measurement is done automatically and the measurement value is displayed on the monitor screen.

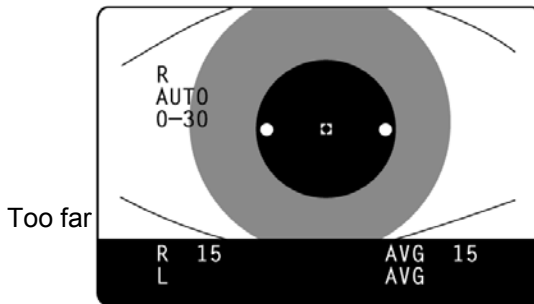

**MEMO**

When the outer alignment mark is not displayed, measurement is not possible. Measurement can be done when the outer alignment mark is displayed after a few seconds.

**MEMO**

- If measurement is not possible under the Auto mode, use the Manual mode. Sometimes Auto mode is not available if the condition of the cornea is unfavorable.

## Display of Measurement Values

Measurement values are displayed on the monitor screen for up to three measurements. From the fourth measurement on, values of earlier measurements are deleted in order.

- Figure only : Correct measurement
- Figure in ( ) : Low in reliability
- ERR : Incorrect measurement
- OVER : Measurement value exceeding the measuring range

## MEMO

If the result is a figure in parentheses or ERR, do the measurement again, making sure the patient does not blink and eyelashes do not get in the outer alignment mark. If OVER is displayed, switch the measuring range to 0-60 and do the measurement again.

## MEASUREMENT UNDER MANUAL MODE

### MEMO

- Adjust the height of the automatic instrument table so that correct measurement values can be obtained by allowing the patient to undergo measurements in a comfortable position.
- Make the patient relaxed so as to secure correct measurement values; make sure the patient does not hold his breath or remain tense.

## Setting the Measurement Mode

The initial status of the measurement mode is AUTO, upon turning the power ON.

- 1 Return to the Measurement screen.
- 2 Press **AM** on the control panel and change the measurement mode display to "MANU".

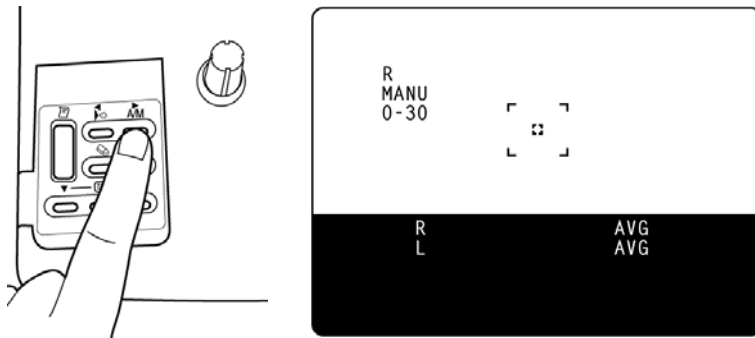

## Setting the Measuring Range

See page 33.

## Alignment and Measurement

The alignment operation is controlled through the control lever.

For details about the adjustment of the machine body using the control lever, see "Memo" on page 34.

- 1** Hold the control lever and pull the machine body towards the operator.

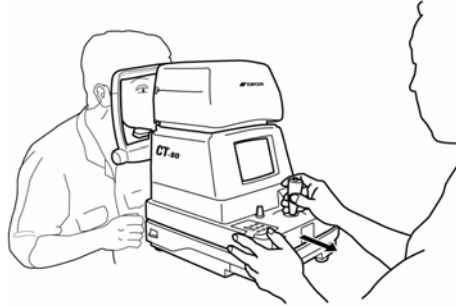

- 2** Move the control lever in directions as needed in order to bring the patient's eye to the center of the monitor screen.

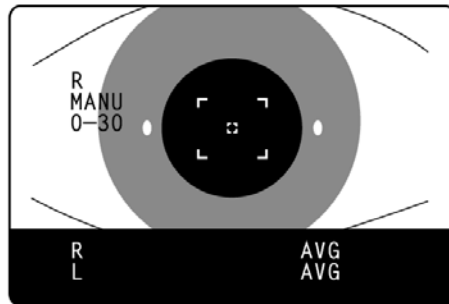

- 3** Tell the patient to gaze at the yellow-green light.
- 4** Move the machine body toward the patient and focus the target eye. A vague alignment dot becomes seen reflected in the cornea.
- 5** Move the machine body in directions as needed in order to get the alignment dot within the inner alignment mark on the monitor screen.

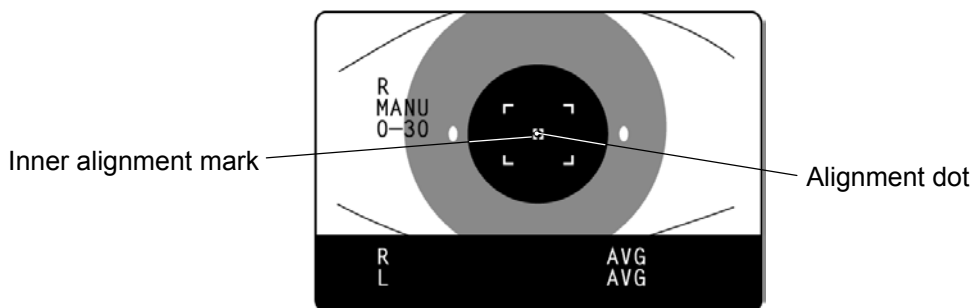



- 6** Holding the alignment dot within the inner alignment mark, slightly push the machine body toward the patient. When the machine body approaches the target eye, the alignment bar and the “FORWARD” display appear on the monitor screen.

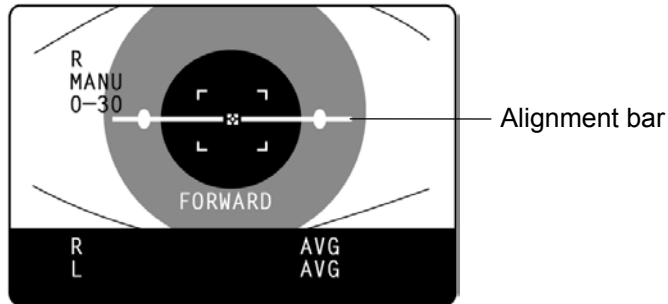

At this moment, be careful not to catch eyelashes and eyelids within the outer alignment mark so as to ensure correct measurements. See descriptions about the alignment bar, “FORWARD” and “TOO CLOSE” on page 36.

- 7** Move the machine body back and forth, with the alignment bar as a reference, while holding the alignment dot within the inner alignment mark. When the alignment is adjusted, the shape of the inner alignment mark changes to a □.

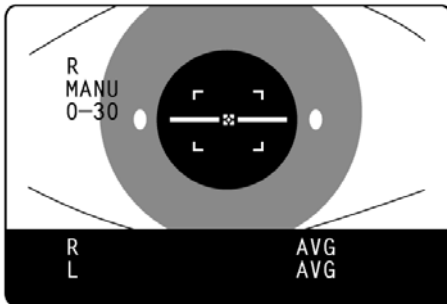

Alignment is not adjusted

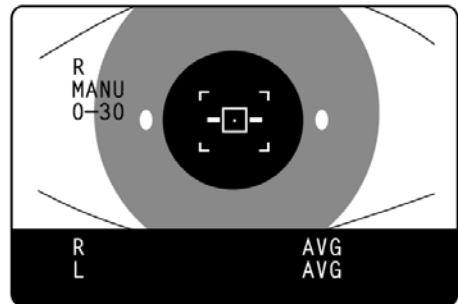

Alignment is adjusted

- 8** After the alignment is adjusted, press **MEASUREMENT SWITCH**. Air is ejected for measurement, and the measurement value is displayed.



In Manual mode, measurement is done by pressing **MEASUREMENT SWITCH** even if the alignment is not adjusted correctly. To ensure high-precision measurements, make sure the alignment is adjusted correctly.

**MEMO**

- If the shape of the inner alignment mark does not change to a □ even after correctly adjusting the alignment, check again to see if the alignment is adjusted correctly. Sometimes the shape of the inner alignment mark does not change to a □ if the condition of the cornea is unfavorable.

## DELETING MEASUREMENT VALUES

---

**1** Press  on the control panel.

All the measurement values of the right and left eyes are deleted and the instrument settings return to their status upon turning the power ON.

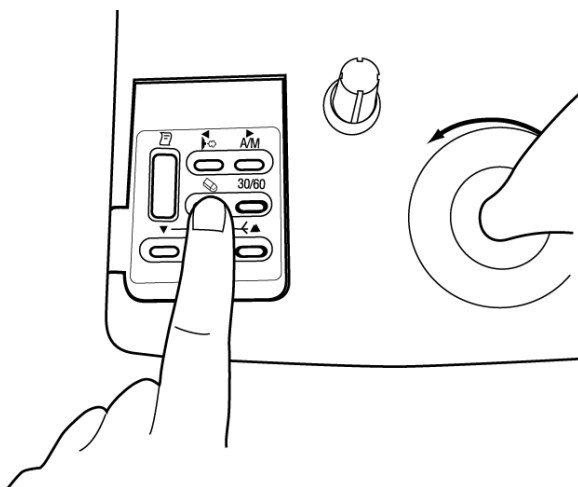

# INDIVIDUAL OPERATIONS

## HOW TO PRINT OUT MEASUREMENT VALUES

### MEMO

- To avoid printer problems due to paper jams, do not feed paper if it is torn or creased.
- To avoid discoloring, particularly of the recording part, do not store the printer paper in holders made of materials containing plasticizers (ex., vinyl chloride).
- To avoid coloring in the white part and discoloring in the recording part, do not use bonds containing solvents. Use water bonds.
- The printer paper is heat sensitive and cannot keep records for long periods of time. Copy the records to other paper for storage.

This machine can print out measurement values with the built-in printer.

**1** Return to the Measurement screen.

**2** Press  on the control panel.

Measurement values of the monitor screen are printed out.

Upon printing, the measured values are deleted automatically from the screen.

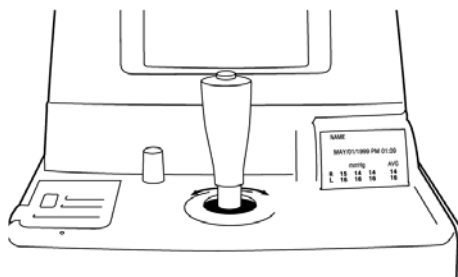

**MEMO** The ERR display is not printed. Also, printing can not be done when no measurement values exist. When a red line appears in the printer paper, replace it. For details about the replacement of paper, see "HOW TO SET PRINTER PAPER" on page 23. Again, use the 58-mm wide TF50KS-E2C (Japan) paper for the printer.

**MEMO** When "PRINTER HEAD IS UP" is displayed, lower the paper retainer lever and press  again.

**3** Hold the paper and pull it diagonally to cut.

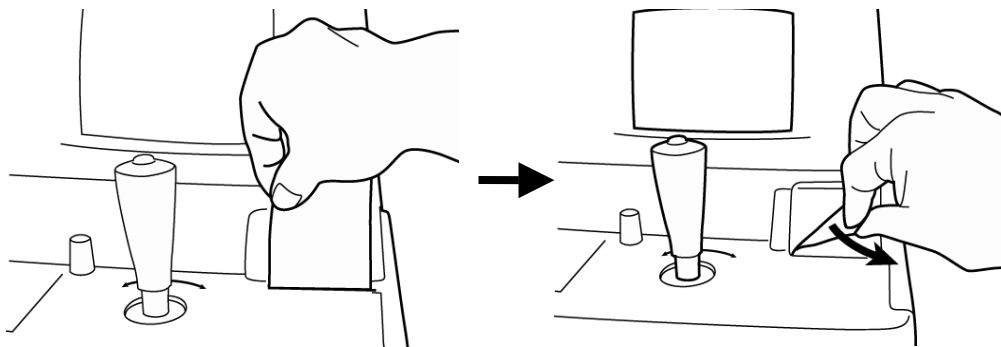

**MEMO**

- To avoid paper jams, cut the paper carefully and evenly.

**HOW TO CORRECT MEASUREMENT VALUES**

**MEMO**

Never set the select switch for more than eight points to avoid malfunctions.

Though the machine is adjusted for displaying optimal measurement values, the values can be corrected within a -4 ~ +3mmHg range.

- 1** Make sure the power is OFF.
- 2** Open the control panel lid.
- 3** Using a screwdriver, turn the “↑” of the select switch.

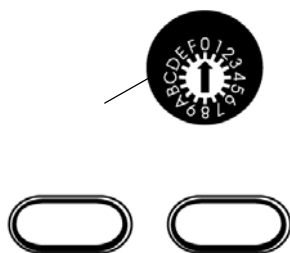

Settings: 0: Base setting For shipment, the switch is set here.  
1: +1mmHg Base setting + 1mmHg  
2: +2mmHg Base setting + 2mmHg  
3: +3mmHg Base setting + 3mmHg  
F: -1mmHg Base setting - 1mmHg  
E: -2mmHg Base setting - 2mmHg  
D: -3mmHg Base setting - 3mmHg  
C: -4mmHg Base setting - 4mmHg

**4** Turn the **POWER SWITCH** ON.

The measurement procedure is exactly the same as with the correction.

### Output via RS-232C

This machine can output data via the RS-232C interface to a personal computer or similar device.

- 1** Make sure the RS-232C OUT is connected.  
For connection, see "HOW TO CONNECT EXTERNAL I/O TERMINALS" on page 14.
- 2** Check the settings for data communication.  
For data communication, see "RS-232C Input/Output Settings" on page 18.
- 3** Obtain the measurements.
- 4** Press  on the control panel.  
"RS-232C DATA OUT" is displayed on the screen and the data output is completed.

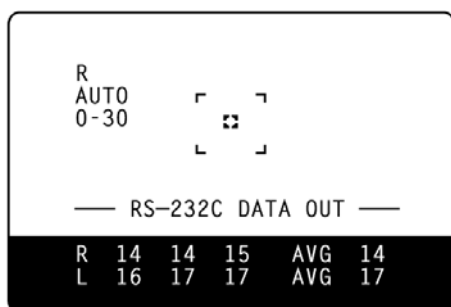

### Input via RS-232C

This machine can input data from a bar code reader and the like via the RS-232C interface.

- 1** Make sure the RS-232C OUT is connected.  
For connection, see "HOW TO CONNECT EXTERNAL I/O TERMINALS" on page 14.
- 2** Check the settings for data communication.  
For data communication, see "RS-232C Input/Output Settings" on page 18.
- 3** Return to the Measurement screen.
- 4** Input the ID No. from the external device.  
The inputted "ID No." is displayed.

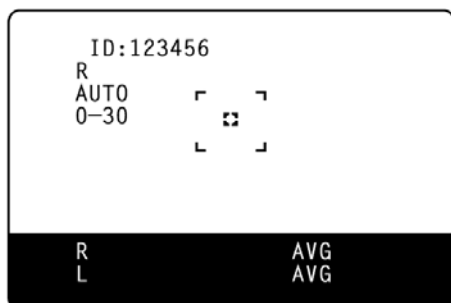

# ORE REQUESTING SERVICE

## CHECKING OPERATIONS

### Air Check

If a problem is suspected, do an air check.

If the result is “NG (+)” or “NG (-),” call your dealer.

For instructions on how to perform an air check, see “Air Check” on page 29.

### Checking Operations



#### WARNING

To avoid electric shocks, do not open the instrument. Refer all servicing to qualified personnel.



#### WARNING

To avoid electric shocks, do not remove the covers from the bottom and top surfaces, TV monitor, measuring unit, etc.

If a problem is suspected, perform checks following the Check List shown below. If the condition is not improved by the suggested remedy or if it is not described in the list, call your dealer.

### CHECK LIST

Problem:	Check point:	Remedy:	Page:
Monitor screen does not work.	Power cable is not plugged into receptacle.	Secure plug in power cable.	P.14
	Power cable is not plugged into machine body.	Plug power cable into machine body.	P.14
	Power save function is on.	Return to normal status.	P.28
	Fuse is burned.	Replace fuse.	P.55
Monitor screen display is not clear.	Monitor screen needs to be readjusted.	Adjust monitor screen.	P.54
	Measuring window needs to be cleaned.	Clean measuring window.	P.52
Auto mode measurement is not possible.	Measuring window needs to be cleaned.	Clean measuring window.	P.52
	Window in nozzle needs to be cleaned.	Clean window in nozzle.	P.53
	Condition of patient's eye is unfavorable.	Measure under Manual mode.	P.38
	Manual mode is on.	Set Auto mode.	P.33
Measurement values have ( ) or ERRs are displayed.	Measuring window is not clear enough.	Clean window in nozzle.	P.53
Paper comes out unprinted.	Printer paper winding is reversed.	Set printer paper correctly.	P.23,26
Paper does not come out.	Printer paper is used up.	Supply printer paper.	P.23, 56
	Paper is jammed.	Remove jammed paper.	P.55
Machine body does not move.	Clamping knob/fixing knob is fastened.	Loosen up clamping knob/fixing knob.	P.8

# REFERENCE

## OPTIONAL ACCESSORIES

### Automatic instrument table AIT-20 and Table Board

Driven by electric power, it can change the height of the instrument as desired so as to enable the patient to undergo measurement in a comfortable position.

Size .....586(W) × 520(D)mm

Table height .....675-865mm (differs by destination)

Table size .....450(W)x500(D)mm

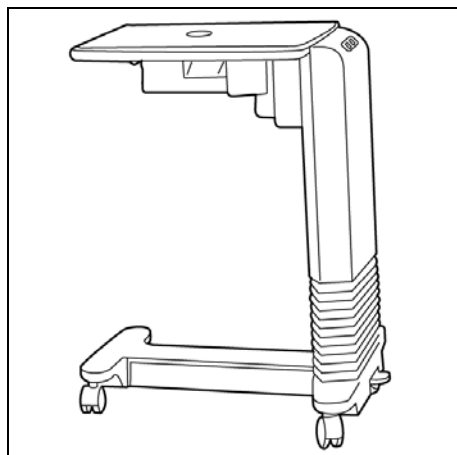

## SPECIFICATIONS & PERFORMANCE

Measuring range	0~60mmHg
Working distance	11mm
Measurement display	Monitor screen (with average value)
Measurement recording	Built-in printer (with average value)
Alignment display	Monitor screen
Monitor screen	5in.
Power saving	Power save system
External I/O terminal	RS232C
Power supply	AC 100, 120, 220, 230 and 240V; 50/60Hz
Power consumption	80VA
Classification	IEC 601-1 CLASS I TYPE B
Operating temperature	10~40°C
Body movement, back & forth	44mm
Body movement, right & left	88mm
Body movement, up & down	28mm
Chinrest adjustment	68mm
Dimensions	272(W)×505(D)×430~458(H)mm
Weight	18kg

\* For product improvements, specifications and appearance may be changed without prior notice.

## RS-232C COMMUNICATION SPECIFICATIONS

### Connector Types

Input terminal: DIN 8-pin (TSC0838-01-2051, Hoshiden)

Output terminal: DSUB 9-pin (DE-9S-N, JAE)

### Terminal Pin Arrangement

· Output terminal: DSUB 9-pin (Pin Nos.1 and 9 are not used.)

Pin No.	Code	Description	I/O
2	RD (RXD)	Data receiving	I
3	SD (TXD)	Data transmission	O
4	ER (DTR)	Data terminal ready	O
5	SG (GND)	Signal ground	I/O
6	DR (DSR)	Data set ready	I
7	RS (RTS)	Request transmission	O
8	CS (CTS)	Transmission ready	I

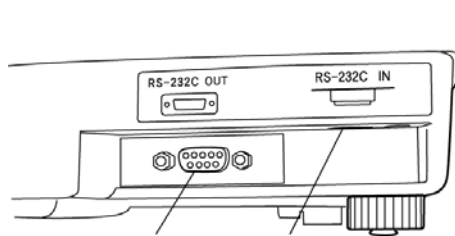

Output terminal      Input terminal

· Input terminal DIN 8-pin (Pin No.1 is not used.)

Pin No.	Code	Code Description	I/O
2	SD (TXD)	Data transmission	I
3	RD (RXD)	Data receiving	O
4	RS (RTS)	Request transmission	O
5	CS (CTS)	Transmission ready	I
6	DR (DSR)	Data set ready	I
7	SG (GND)	Signal ground	I/O
8	ER (DTR)	Data terminal ready	I

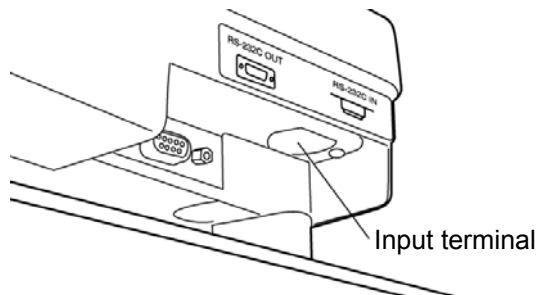

Input terminal



## Transmission Formula

Mode 1, 2, 3

Synchronization	Non-synchronous
Communication speed	2400/9600 bps
Start bit	1 bit
Stop bit	2 bit
Data length	8 bit
Parity	None
Operating code	ASCII code

Mode 4, STD1 mode

Synchronization	Non-synchronous
Communication speed	2400/9600 bps
Start bit	1 bit
Stop bit	1 bit
Data length	8 bit
Parity	None
Operating code	ASCII code

## Contents of Data Transmission

Communication format Mode 1, 3:

Model name, Type No.            10 byte  
 Time/Date                            19 byte  
 R (right eye) average data        9 byte  
 L (left eye) average data         9 byte

\* When the content is data with parentheses only, the average value is sent; when it is OVER data only, OVER is sent; and when there is no data or ERRs only, a space is sent.

(Example)

SOH																					
C	T	-	8	0	_	_	_	_	_	CR	LF										
M	A	Y	/	0	1	/	'	9	9	_	A	M	_	1	0	:	0	0	CR	LF	
STX																					
_	R	_	_	1	3	.	3	_	CR												
_	L	_	_	1	5	.	0	_	ETX	CR	LF										
EOT																					

Communication format Mode 2:

Model name, Type No. 10 byte  
 Time/Date 19 byte  
 Measurement value (right or left eye) average data 9 byte  
 \* If ERRs only, transmission is not done.

(Example)

SOH																				
C	T	-	8	0	_	_	_	_	_	CR	LF									
M	A	Y	/	0	1	/	'	9	9	_	A	M	_	1	0	:	0	0	CR	LF
STX																				
_	L	_	_	1	5	.	0	_	ETX	CR	LF									
EOT																				

Communication format Mode 4, STD 1:

- Data Transmission
  - Model name, Type No. 15 byte
  - Machine No. 2 byte
  - ROM version 10 byte
  - ID No. 13 byte
  - Work ID No. 13 byte
  - Machine work ID No. 4 byte
  - Time/Date 20 byte
  - R (right eye) average data 9 byte
  - L (left eye) average data 9 byte

(Example)

@	CR																							
C	T	-	8	0	_	_	_	_	_	_	_	_	_	0	1	1	.	0	0	_	_	_	_	CR
0	1	2	3	4	5	6	7	8	9	0	1	2	3	CR										
0	1	2	3	4	5	6	7	8	9	0	1	2	3	CR										
0	1	2	3	CR																				
*	CR																							
_	M	A	Y	/	0	1	/	'	9	9	_	A	M	_	1	0	:	0	0	CR	LF			
_	R	_	_	1	3	.	3	_	CR															
_	L	_	_	1	5	.	0	_	CR															
*	CR																							
EOT																								

- Data Receiving  
Patient ID data 13 byte

(Example)

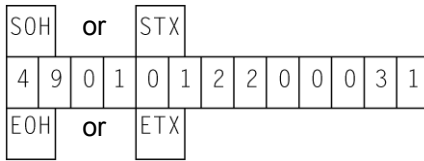

## Setting RS-232C Communication Conditions

In the Menu screen, move the cursor using the  $\Delta$  ,  $\nabla$  keys on the control panel, and press **MEASUREMENT SWITCH** . Further, move the cursor to an item to be changed on the screen shown below, and press **MEASUREMENT SWITCH** . [SET→\*\*\*\*] is displayed at the bottom of the screen. Change the setting using  $\Delta$  ,  $\nabla$  . After changing, the setting is registered by pressing **MEASUREMENT SWITCH** . After setting, move the cursor to EXIT and press **MEASUREMENT SWITCH** to return to the Menu screen. For further details, see “RS-232C Input/Output Settings” on page 18.



Items of setting (5 items)

- Machine No. (EQUIPMENT) Set value: 0~99. (For shipment, “1” is set.)  
When more than one unit of inspection equipment is installed in the same hospital, for example, data can be controlled using these Machine Nos.
- Input ID mode (ID MODE) Set value: 1 or 2 (For shipment, “1” is set.)  
1. For inputting patients' ID numbers.  
2. For inputting the temporary ID numbers of new patients.
- Work ID No. (WORK ID NO.) Set value: 0~9999 (For shipment, “0” is set.)  
Desired serial numbers can be attached to measurement results. The number is automatically added (1 at a time) each time the printing of data communication is performed.

· Communication format (FORMAT)

Format: OFF, MODE 1, MODE 2, MODE 3, MODE 4, STD 1 (For shipment, "OFF" is set.)

MODE 1: When  is pressed, communication is done after printing.

MODE 2: Data communication is done every measurement.

MODE 3: When  is pressed, communication is done without printing.

MODE 4: When  is pressed, communication is done without printing.

STD 1: When  is pressed, communication is done after printing.

**MEMO**

When Mode 1, 2 or 3 is set, data is transmitted automatically without confirmation from the receiver side. When STD 1 is set, communication is controlled by RTS-CTS.

**MEMO**

Under the RTS-CTS control, if no CS (CTS) signal is returned from the receiver side, transmission can be canceled by pressing . Also, if no DR (DSR) signal is returned, it is recognized as a communication failure and FAIL is displayed on the monitor screen.

· Communication speed (SPEED)

Baud rate: 2400, 9600 (bps) (For shipment, 2400bps is set.)



# MAINTENANCE AND CHECKING

## ACCURACY MAINTENANCE

### Cleaning the Measuring Window Glass

- To secure auto alignment and correct measurement values, clean the measuring window glass after each day's work.
- Clean the glass when "CLEAN THE MEASURING WINDOW GLASS" is displayed on the monitor screen.



#### CAUTION

To clean the measuring window glass and the window glass inside the measuring nozzle, use ethanol. Using other chemicals may cause damage to the patient's eye during measurement.

#### MEMO

- Do not use tissues, as they may make the stain more noticeable.
- Do not use tweezers or gauze, as these may scratch the lens and glass surfaces.

- 1 Prepare the ethanol.
- 2 Using a blower, remove dust and dirt from the glass surface.
- 3 Moisten the applicator with ethanol.
- 4 Wipe the glass surface lightly with the applicator, from the center outward.

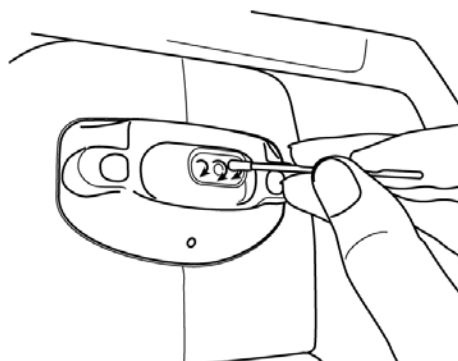

- 5 Use a new applicator and wipe the glass surface in a similar manner; repeat this several times.   
 Wiping the glass surface

#### MEMO

To ensure thorough removal of grease from the window glass, be sure to replace the applicator and use a new one for each of these repeated wiping operations.

- 6 Cleaning is completed when grease is thoroughly removed.  
If stains cannot be removed easily, call your dealer.

#### MEMO

When the measuring window glass becomes stained "CLEAN THE MEASURING WINDOW GLASS" is displayed on the monitor screen.

## ●leaning the Window Glass inside the Nozzle

- When the window glass inside the nozzle becomes stained, it makes the fixation target unclear, causing errors in auto alignment and measurement values. If the fixation target is unclear or measurement values with parentheses are frequent, clean the window glass inside the nozzle.
- Clean the glass when “CLEAN THE CHAMBER GLASS” is displayed on the monitor screen.

 <b>CAUTION</b>	To clean the measuring window glass and the window glass inside the measuring nozzle, use ethanol. Using other chemicals may cause damage to the patient's eye during measurement.
--	--

<b>MEMO</b>	<ul style="list-style-type: none"><li>• Do not apply unreasonable force to the measuring nozzle while cleaning.</li><li>• To avoid problems, do not leave the cotton fibers inside.</li><li>• Be sure to use only the attached applicator.</li></ul>
-------------	--

- 1 Prepare the ethanol.
- 2 Moisten the applicator with ethanol.
- 3 Insert the applicator into the nozzle, lightly touch the glass surface, and turn the applicator a few times.

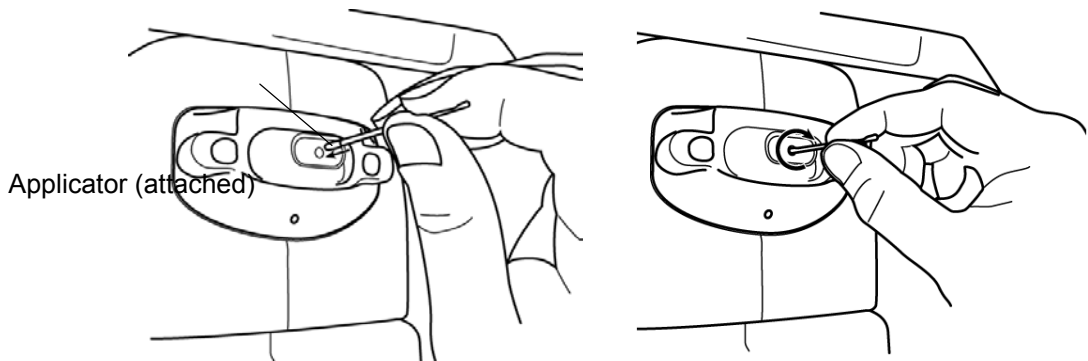

- 4 Use a new applicator and wipe the glass surface in a similar manner; repeat this a few times .

**MEMO** The used applicator contains grease and it only scatters grease if used again; the light transmittance is not improved at all. Be sure to replace the applicator and use a new one for each of these repeated cleaning operations.

- 5 Cleaning is completed when the grease is thoroughly removed.

If stains cannot be removed easily, call your dealer. Press  for a air check to confirm normal operation.

**MEMO** When the window glass inside the nozzle becomes stained, it makes the fixation target unclear and “CLEAN THE CHAMBER GLASS” is displayed on the monitor screen.

## Daily Maintenance

- This machine must be kept free of dust; apply the measuring window cap and dust cover when not in use.
- When not in use, turn the **POWER SWITCH** OFF.

## Ordering Consumable Supplies

- When placing an order for consumable supplies, tell your dealer the product name, part code and quantity.

Name	Code
Chinrest pad	40310 4082
Silicone cloth	31087 2007
Dust cover	42360 9002
Chinrest pad pin	42364 4021

Name	Code
Applicator	41601 8606
Printer paper	44800 4001
Fuse 125V-3A-M	41801 5012
Fuse 250V-1.5A-M	42364 5313



## Adjusting the Monitor Screen

- Although the machine is adjusted for optimal screen conditions before shipment, a screen readjustment may be required due to vibrations during transportation.
- To adjust the contrast and brightness, move the BRIGHT/CONT. knobs after turning them all the way to the right, as viewed from the operator.

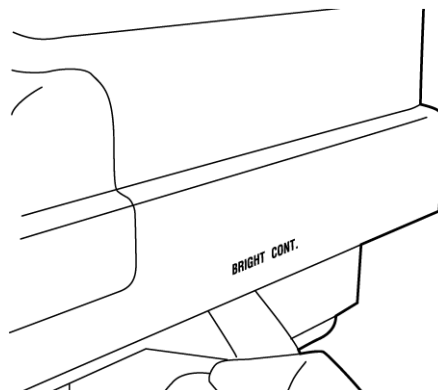

## Paper Jam in Printer

### MEMO

- If paper is jammed inside the printer, printing is not complete. Attempts to forcibly use the printer may lead to problems.

- Remove the printer cover, release the paper retainer lever and remove the jammed paper.

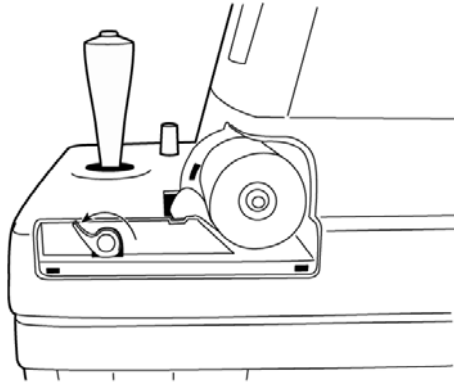

## Replacing the Fuse



### WARNING

To avoid electrical shock and fire, unplug the power cable before removing the fuse cover. Additionally, be sure to replace the fuse cover before plugging in the power cable.



### WARNING

Use only the attached fuses. Using other fuses may cause a fire.

- 1** Make sure the power is OFF and the power cables are unplugged.
- 2** Press the fuse holder with a screwdriver and turn it counterclockwise. The fuse holder can be taken out.

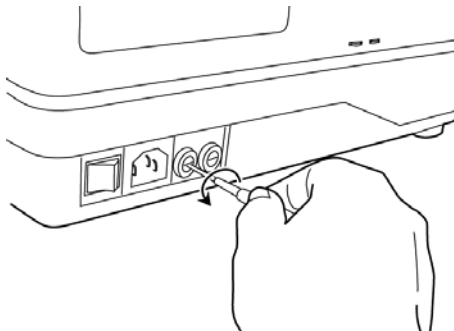

Removing the Fuse Holder



- 3** Replace the fuse with the attached fuse.

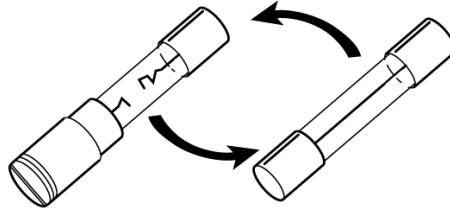

Replacing the Fuse

- 4** Press the fuse holder with a screwdriver and turn it clockwise. The fuse holder is now reset.

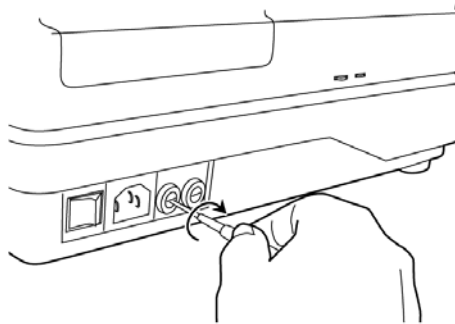

Setting the Fuse Holder

## SPECIAL NOTES ON CLEANING

### ● Cleaning the Outer Cover



#### CAUTION

Do not use or apply any spray-typed cleaner near the instrument. If a drop of cleaner remains inside the measuring nozzle, the patient's eye may be injured during measurement.

#### MEMO

To avoid discoloring/deterioration of the plastic components, do not use volatile solvents (benzine, thinner, gasoline, etc.).

- When the outer cover, operation panel and the like become stained, clean them with a dry cloth. If the stain is extreme, a neutral detergent for tableware may be used by diluting it with tepid water. Soak the cloth in the solution, squeeze it out, and then use it to wipe off stains.

---

**When calling please give us the following information about your unit:**

- Machine type: CT-80
- Manufacturing No. (Shown on the rating plate on the right side of the base.)
- Period of Usage (Please give us the date of purchase).
- Description of Problem (as detailed as possible).

---

COMPUTERIZED TONOMETER (CT-80)

INSTRUCTION MANUAL

Version of 1999 (9906-100LW0)

Date of issue: 1st, June, 1999

Published by  **TOPCON**

75-1 Hasunuma-cho, Itabashi-ku, Tokyo, 174-8580 Japan.

## COMPUTERIZED TONOMETER

---

# CT-80

### TOPCON AMERICA CORPORATION

CORPORATE OFFICE: 37 West Century Road, Paramus, New Jersey 07652, U.S.A. Phone: 201-261-9450 Fax: 201-387-2710 www.topcon.com

#### TOPCON CANADA INC.

110 Provencher Avenue, Boisbriand, QC J7G 1N1 CANADA Phone: 514-430-7771 Fax: 514-430-6457

### TOPCON OMNI SYSTEMS, INC.

Valley Forge Business Center, 2430 Blvd. of the Generals, Norristown, PA 19403, U.S.A. Phone: 610-630-9200 Fax: 610-630-6428

### TOPCON EUROPE B.V.

(European Representative)

ESSE Baan 11, 2908 LJ Capelle a/d IJssel, THE NETHERLANDS. Phone: 010-4585077 Fax: 010-4585045 www.topconeurope.com

#### TOPCON DEUTSCHLAND G.m.b.H.

Halskestrasse 7 47877 Willich, GERMANY. Phone: 02154-9290 Fax: 02154-929111

#### TOPCON ESPAÑA S.A.

HEAD OFFICE: Frederic Mompou 5, 08960, Sant Just Desvern Barcelona, SPAIN Phone: 93-4734057 Fax: 93-4191532

MADRID OFFICE: Avenida Ciudad de Barcelona 81, 1 Planta 28007, Madrid, SPAIN Phone: 91-5524160 Fax: 91-5524161

#### TOPCON S.A.R.L.

HEAD OFFICE: 104/106, Rue Rivay, 92300, Levallois-Perret, FRANCE. Phone: 014106-9494 Fax: 014739-0251

LYON OFFICE: 138, Avenue du 8 Mai 1945, 69100 Villeurbanne, FRANCE. Phone: 0478688237 Fax: 0478681902

#### TOPCON SCANDINAVIA A. B.

Industrivägen 4 P.O.Box 2140 43302 Sävedalen SWEDEN. Phone: 031-261250 Fax: 031-268607

#### TOPCON (GREAT BRITAIN) LTD.

Topcon House, Kennet Side, Bone Lane, Newbury, Berkshire RG14 5PX United Kingdom. Phone: 01635-551120 Fax: 01635-551170

### TOPCON SINGAPORE PTE.LTD.

Alexandra Distripark Block 4, #05-15, Pasir Panjang Road, Singapore 118491. Phone: 2780222 Fax: 2733540 web.singnet.com.sg/Topcon

#### TOPCON INSTRUMENTS (MALAYSIA) SDN. BHD.

Lot 226 Jalan Negara 2, Pusat Bandar Taman Melawati, Taman Melawati 53100 Kuala Lumpur, MALAYSIA. Phone: 03-4079801 Fax: 03-4079796

#### TOPCON INSTRUMENTS (THAILAND) CO., LTD.

77/162 Sinn Sathorn Tower, 37th Fl., Krungthongburi Rd., Klongtong Sai, Klongsarn, Bangkok 10600. Phone: 662-440-1152~7 Fax: 662-440-1158

### TOPCON AUSTRALIA PTY.LTD.

408 Victoria Road, Gladesville, NSW 2111, AUSTRALIA. Phone: 02-9817-4666 Fax: 02-9817-4654 www.topcon.com.au

### TOPCON KOREA CORPORATION

Hyobong Bldg., 1-1306, Seocho-Dong, Seocho-Gu, Seoul, KOREA. Phone: 02-3482-9231 Fax: 02-3481-1928 www.topcon.co.kr

### TOPCON OPTICAL (H.K.) LTD.

2/F Meeco Industrial Bldg., No.53-55 Au Pui Wan Street, Fo Tan Road, Shatin, N.T., Hong Kong

Phone: 2690-1328 Fax: 2690-2221 E-mail: sales@topcon.com.hk

### TOPCON CORPORATION BEIJING OFFICE

Room No. 962 Poly Plaza Building, 14 Dongzhimen Nandajie Dongcheng District, Beijing, 100027, CHINA. Phone: 10-6501-4191~2 Fax: 10-6501-4190

### TOPCON CORPORATION BEIRUT OFFICE

P.O.BOX 70-1002 Antelias, BEIRUT-LEBANON. Phone: 961-4-523525/523526 Fax: 961-4-521119

### TOPCON CORPORATION DUBAI OFFICE

Office No.102 KHALAF RASHID AL NAYLI BLDG., Deira, Dubai, UAE. Phone: 971-4-696511 Fax: 971-4-695272

## TOPCON CORPORATION

75-1 Hasunuma-cho Itabashi-ku Tokyo 174-8580 Japan

Phone: 3-3558-2520 Fax: 3-3960-4214